



Rayco Supply, Inc

Industrial and Firefighting Products

“Right Away - Yours”

2020 Edition



YOUR MISSION IS OUR MISSION

27
Years of Service

PROCUREMENT OPTIONS



Operated by Virginia Industries for the Blind

MILSTRIP Accepted



Super Servmart NOB

Servmart LCI Mayport

Servmart Bremerton

Servmart Whidbey Island



*FedMall Contract:
SP47W1-17-D-0028

MILSTRIP Accepted



*GSA Contracts:

Schedule 84 GS-07F-074BA

Schedule 51v GS-21F-109BA

For more information on procurement options or products please contact Rayco Supply and we will be happy to assist you.

Phone: 757-431-0698

Fax: 757-431-2634

Email: Rayco@RaycoSupply.com

www.raycosupply.com



*Woman-Owned Small Business
Cage 0XGL1



* Minimum Order Requirement of \$50.00 *

TO ORDER

Call: 1-757-431-0698

email: RAYCO@RAYCOSUPPLY.COM

Visit our website: RAYCOSUPPLY.COM

TABLE OF CONTENTS

Aviation	4 – 23
Flight Deck Apparel	4 – 7
Flight Suits	8 – 9
Foul Weather	10 – 11
Gloves, Goggles, Vests	12 – 13
Proximity Gear	14 – 15
Air Dept. Essentials & 80R-14	16 – 19
Tools, Manual Impact Wrenches, Vacuums, Deck Nozzle	20 – 22
Conex Boxes & Lockers	23
Damage Control	24 – 45
Firefighting & Anti Flash	24 – 28
Coveralls	29
Hoses, Pumps, Nozzles, Straps	30
Fire Suppression	31 – 32
Gas Detection	33 – 34
Overboard Discharge, Ram Fan, WSOA & RDD	35 – 36
Deck Drains, Strainers, Other DC Items	37 – 38
Flashlights, Tools, & Battle Lanterns	39 – 40
Kits & Bags	41 – 43
DC Signage & Plates	44 – 45
Engineering	46 – 85
Coveralls, Anti-Exposure & Safety Items	46 – 49
LED Lighting	50 – 51
Welding	52 – 57
Drain Cleaning, Head Parts, & Flowmeters	58 – 61
Metal, Fittings, Valves & Hardware	62 – 67
Metal Working Machinery & Machine Tools	68 – 70
Power & Pneumatic Tools	71
Locks & Keys	72 – 73
Engravers & Engraving Sheets	74 – 77
Wood Working, Abrasives & Hand Tools	78 – 81
3D Printer Consumables & Safety Storage Cabinets	82
Material Handling, Storage, & Custom Shipboard Furniture	83 – 85
INSURV	86 – 94
Ladders, Treads, & Pins	86 – 87
Deck Grating, Vent Diffusers & Galley Vent Covers	88 – 89
Additional INSURV Items List	90
Doors, Hand Wheels & Non-Skid	91
Plumbing Fixtures	92
Lagging & LED's	93 – 94
Tactical	95 – 103
Body Armor	95
Active Apparel	96 – 103
Janitorial	104– 105
Ability One Items	106

AVIATION



AVIATION



Part Number	Description	Size
76DF2340FDSUR	Flight Deck Jersey, Red	SM, MED, LG, XLG, 2XL, 3XL
76DF2340FDSUBL	Flight Deck Jersey, Blue	SM, MED, LG, XLG, 2XL, 3XL
76DF2340FDSUBR	Flight Deck Jersey, Brown	SM, MED, LG, XLG, 2XL, 3XL
76DF2340FDSUP	Flight Deck Jersey, Purple	SM, MED, LG, XLG, 2XL, 3XL
76DF2340FDSBW	Flight Deck Jersey, White	SM, MED, LG, XLG, 2XL, 3XL
76DF2340FDSBY	Flight Deck Jersey, Yellow	SM, MED, LG, XLG, 2XL, 3XL
76DF2340FDSBG	Flight Deck Jersey, Green	SM, MED, LG, XLG, 2XL, 3XL

*** Specify size when ordering ***



Available Colors



Available on



SP47W1-17-D-0028



Schedule 84 GS-07F-074BA





















“Right Away - Yours”

Contract Availability



AVIATION



Part Number	Description (sizes 3 - 16 half sizes starting at 3.5)
76B2516	 Boots, Flight Deck US Navy Approved, Black, 6
76B2517	 Boots, Flight Deck US Navy Approved, Black, 7
76B2518	 Boots, Flight Deck US Navy Approved, Black, 8
76B2519	 Boots, Flight Deck US Navy Approved, Black, 9
76B25110	 Boots, Flight Deck US Navy Approved, Black, 10
76B25111	 Boots, Flight Deck US Navy Approved, Black, 11
76B25112	 Boots, Flight Deck US Navy Approved, Black, 12
76B25113	 Boots, Flight Deck US Navy Approved, Black, 13
76B25114	 Boots, Flight Deck US Navy Approved, Black, 14
76B25115	 Boots, Flight Deck US Navy Approved, Black, 15
Part Number	Description (sizes 3 - 16 half sizes starting at 3.5)
76BR2516	 Boots, Flight Deck US Navy Approved, Brown, 6
76BR2517	 Boots, Flight Deck US Navy Approved, Brown, 7
76BR2518	 Boots, Flight Deck US Navy Approved, Brown, 8
76BR2519	 Boots, Flight Deck US Navy Approved, Brown, 9
76BR25110	 Boots, Flight Deck US Navy Approved, Brown, 10
76BR25111	 Boots, Flight Deck US Navy Approved, Brown, 11
76BR25112	 Boots, Flight Deck US Navy Approved, Brown, 12
76BR25113	 Boots, Flight Deck US Navy Approved, Brown, 13
76BR25114	 Boots, Flight Deck US Navy Approved, Brown, 14
76BR25115	 Boots, Flight Deck US Navy Approved, Brown, 15

Available in Regular & Wide



TO ORDER
 Call: 1-757-431-0698
 email: RAYCO@RAYCOSUPPLY.COM
 Visit our website: RAYCOSUPPLY.COM

AVIATION

Flight Deck Pants



- Fire Resistant Tear / Abrasion Resistant
- Durable, lightweight, and wind blocking
- Interior elastic waist system
- Extra-wide belt loops
- Two anti-FOD front pockets with hook-and-loop closure
- Two anti-FOD side cargo pockets with easy Flight Deck Wand storage
- Two articulated knee patches reinforced with double fabric layers
- Rear pant seat reinforcement
- Advanced patterning for extra comfort and flexibility

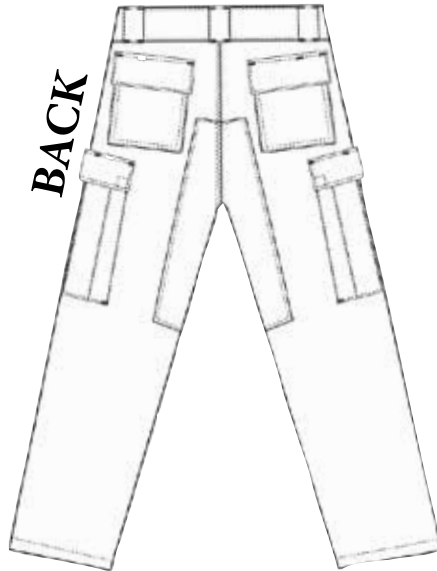
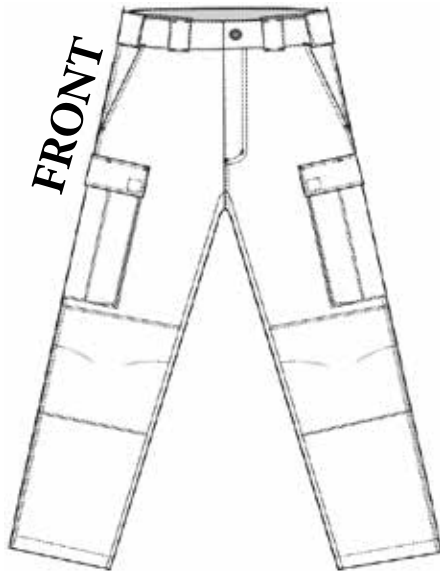

Size	Waist	Length	Inseam
X-Small	24-26	Short *	30
Small	28-30	Regular	32
Medium	32-34	Long *	34
Large	36-38	Extra Long *	36
X-Large	40-42	Available in Navy & Khaki	
2X-Large	44-46	Short, Long, & Extra Long lengths are special order items	

Other sizes are available through special order. Call for pricing and delivery information



Available on



SP47W1-17-D-0028



Schedule 84 GS-07F-074BA

**Designed by AB's for
the Flight Deck!!**

“Right Away - Yours”

Contract Availability



FEDMALL



GSA ADVANTAGE

AVIATION

One Piece Flight Suits



Part Number	Description
76PHX17129450KH 	Fortrex Flight Suit Khaki
76PHX17129450SG 	Fortrex Flight Suit Sage Green

Specify chest size and pant length
 Available sizes: Chest: 32 - 52
 Length: Short - Extra Long



Fortrex By Drifire
 Perfect for HOT weather
 27-P Design



★ PROPPER®
 RIGHT TO THE CORE



Nomex
 27-P Design

Part Number	Description
76CWU27P	Nomex Flight Suit Khaki
76CWU27P- G	Nomex Flight Suit Freedom Green



AVIATION

Two Piece Flight Suits & Combat Style Clothing

Part Number	Description	Colors	Size	Lengths
76PHX2JA	Flight Suit, Navy Approved, Jacket for 2-pc	Khaki, Sage	XS, S, M, L, XL, 2XL	Short, Regular, Long
76PHX2PA	Flight Suit, Navy Approved, Pant for 2-pc	Khaki, Sage	XS, S, M, L, XL, 2XL	Short, Regular, Long
76PHX2550FSJ	Flight Suit, Army/Airforce, Jacket for 2-pc	Multicam	XS, S, M, L, XL, 2XL	Short, Regular, Long
76PHX2550FSP	Flight Suit, Army/Airforce, Pant for 2-pc	Multicam	XS, S, M, L, XL, 2XL	Short, Regular, Long

*** Specify size when ordering ***



DRIFIRE Combat Shirt - Size Chart				
Size	Alter	Chest	Height	Sleeve Length
X-Small	Short	< 33	63 - 67	30
	Regular	< 33	67 - 71	31
	Long	< 33	71 - 75	32
Small	Short	33 - 37	63 - 67	31
	Regular	33 - 37	67 - 71	32
	Long	33 - 37	71 - 75	33
Medium	Short	37 - 41	63 - 67	32
	Regular	37 - 41	67 - 71	33
	Long	37 - 41	71 - 75	34
Large	Short	41 - 45	63 - 67	33
	Regular	41 - 45	67 - 71	34
	Long	41 - 45	71 - 75	35
X-Large	Short	45 - 49	63 - 67	34
	Regular	45 - 49	67 - 71	35
	Long	45 - 49	71 - 75	36
XX-Large	Short	> 49	63 - 67	35
	Regular	> 49	67 - 71	36
	Long	> 49	71 - 75	37

Part Number	Description	Color	Size
76DF2550CS	Shirt, Combat, Army/Airforce	Multicam (Short, Regular, Long)	XS, M, L, XL, 2XL, 3XL
76DF27129CS	Shirt, Combat, Navy Approved	Khaki, Sage (Short, Regular, Long)	XS, M, L, XL, 2XL, 3XL

Available on



Don't see what you are looking for?
Contact your Rayco Rep for more information
regarding the products in this category.



SP47W1-17-D-0028



Schedule 84 GS-07F-074BA

Contract Availability

“Right Away - Yours”



FEDMALL



GSA ADVANTAGE

AVIATION

Jackets & Fleeces



Combat Fleece

Part Number	Description	Size
76DF2393FHACB	Combat Fleece Hoodie, Coyote Brown	S - 2XL
76DF2393FHADS	Combat Fleece Hoodie, Desert Sand	S - 2XL



Insulated Bomber Jacket

Part Number	Description	Size (Short)	Size (Reg)	Size (Long)
76JLR8NV	Insulated Bomber Jacket, HRC4, Navy	XS - 6XL	XS - 8XL	XS - 7XL
76JLR8KH	Insulated Bomber Jacket, HRC4, Khaki	XS - 6XL	XS - 8XL	XS - 7XL

Part Number	Description	Size (Short)	Size (Reg)	Size (Long)
76JLP8NV	Insulated Deluxe Parka, CAT 3, Navy	XS - 6XL	XS - 9XL	XS - 8XL
76JLP8KH	Insulated Deluxe Parka, CAT 3, Khaki	XS - 6XL	XS - 9XL	XS - 8XL



Insulated Deluxe Parka



Flight Jacket

Part Number	Description	Color	Size
76CWU36P 	36/P Flight Jacket, Summer Weight	Sage, Tan	S - XL
76CWU45P	45/P Flight Jacket, Winter Weight	Sage, Tan	S - XL



Cold Weather Balaclavas



Product Number	Description
76DF2560CBB	Balaclava, Cold Weather, Universal Size, Color-Black
76DF2560CBCB	Balaclava, Cold Weather, Universal Size, Color-Coyote Brown
76DF2560CBDS	Balaclava, Cold Weather, Universal Size, Color-Desert Sand
76DF2560CBFG	Balaclava, Cold Weather, Universal Size, Color-Foliage Green

Rain Gear

Product Number	Description (Also Available in Yellow)
769142664	Rain suit, 3 Piece with Hood, Green, Small
768261428	Rain suit, 3 Piece with Hood, Green, Medium
76964268	Rain suit, 3 Piece with Hood, Green, Large
76910635	Rain suit, 3 Piece with Hood, Green, X-Large



Product Number	Description
76DF2GCBBOM_	Storm System Hard Shell Gore-Tex Pyrad Bomber Length Jacket w/ Hood, Coyote
76DF2G2CBPANT _	Storm System Hard Shell Gore-Tex Pyrad Over Pant, Coyote



Product Number	Description
762029003	H2O Proof Parka w/ Hood, Coyote, Small Regular
762029004	H2O Proof Parka w/ Hood, Coyote, Medium Regular
762029005	H2O Proof Parka w/ Hood, Coyote, Large Regular
762029006	H2O Proof Parka w/ Hood, Coyote, X-Large Regular

- Available in Black, MultiCam, and Olive Drab
- 2X & 3X Available
- Long Lengths Available & Trousers sold separately

“Right Away - Yours”

Contract Availability



FEDMALL



GSA ADVANTAGE

Flight Deck Gear



Product Number		Description
76276073		Gloves, Flight Deck Black, Small
76276074		Gloves, Flight Deck Black, Medium
76276075		Gloves, Flight Deck Black, Large
76276076		Gloves, Flight Deck Black, X-Large
76276013		Gloves, Flyer, Nomex, Green, Size 7 (Tan & Black Available)
76276014		Gloves, Flyer, Nomex, Green, Size 8 (Tan & Black Available)
76276015		Gloves, Flyer, Nomex, Green, Size 9 (Tan & Black Available)
76276016		Gloves, Flyer, Nomex, Green, Size 10 (Tan & Black Available)
76276053		Gloves, Fuel Handler, Small
76276054		Gloves, Fuel Handler, Medium
76276055		Gloves, Fuel Handler, Large
76276056		Gloves, Fuel Handler, X - Large



Part Number		Description
4819811350		Goggles with Shadow Lens ESS
487400410		Goggles, Flight Deck Low Profile ESS



MK-1 Inflatables



- Flame Resistant, Breathable Fabric
- Lightweight
- NAVSEA Approved
- Reflective Tape on shoulders and back
- Velcro patch over pocket
- Available Colors : White, Brown, Blue, Yellow, Purple, Green, Red
- Sizes: S - XXL

MK-1 Vests (Float Coat)

Part Number	Description
45MD3040	MK-1 Vest (Complete) Includes: Bladder, CO2 Cartridge, Light, Whistle, Marker (Actuator Sold Separately)
45441	MK-1 Vest, Shell Only
45I701KIT00NAV	Actuator for MK-1 Vest
45I701SPI00NAV	Chemical Pills 10/pack



45I440YEL00NAV



45IC24SGL00000



45I921LTE00NAV



453000001265

Replacement Parts

Part Number	Description
45I440YEL00NAV	Inflatable Bladder
45IC24SGL00000	CO2 Cartridge, 24g
45I921LTE00NAV	Strobe Light, Water Activated
453000001265	Signaling Whistle
45I702DYE00NAV	Dye Marker

Hydration Packs

SOURCE is the only hydration system in the market with a Glass-Like film that requires almost no maintenance to stay clean and bio-film free.



The Tactical 3L Hydration Pack is our most popular hydration system. It can be worn backpack style, inserted in a packpack, or directly attached via MOLLE on vests or backpacks using the QCA buckle system.



Part Number	Description
434000330102	Tactical 2L Hydration Pack - Black
434000330103	Tactical 3L Hydration Pack - Black



Additional Color Options:

Coyote, German Flecktarn Desert, Multicam, Olive, German Flecktarn Woodland

“Right Away - Yours”

Contract Availability



FEDMALL



GSA ADVANTAGE

AVIATION

Proximity Gear



48HTLPLITEFRC - Complete Helmet



48LTO76I2TC



48GLBPRRW



48LTO76I2TP



48BT6220

All Items Available on



SP47W1-17-D-0028



Schedule 84 GS-07F-074BA

Honeywell



TO ORDER

Call: 1-757-431-0698

email: RAYCO@RAYCOSUPPLY.COM

Visit our website: RAYCOSUPPLY.COM

AVIATION

48NC9384180 - Cover



48NC9313491 - Face Shield



48SPDBC - Proximity Suspenders



MORNING PRIDE

Aluminized Pbi™/Kevlar®



Part Number	Description
48LTO76I2TCM	Proximity Jacket, Medium, NFPA 1971 - Current Ed.
48LTO76I2TCL	Proximity Jacket, Large, NFPA 1971 - Current Ed.
48LTO76I2TCXL	Proximity Jacket, X-Large, NFPA 1971 - Current Ed.
48LTO76I2TPM	Proximity Pants, Medium, NFPA 1971 - Current Ed.
48LTO76I2TPL	Proximity Pants, Large, NFPA 1971 - Current Ed.
48LTO76I2TPXL	Proximity Pants, X-Large, NFPA 1971 - Current Ed.
48GLBPRRWAM	Proximity Gloves, Medium NFPA 1971 - Current Ed.
48GLBPRRWAL	Proximity Gloves, Large NFPA 1971 - Current Ed.
48GLBPRRWAXL	Proximity Gloves, X-Large NFPA 1971 - Current Ed.
48HTLPLITEFRC	Proximity Helmet, LiteForce NFPA 1971 - Current Ed.
48NC9313491	Proximity Face Shield, Gold NFPA 1971 - Current Ed.
48HPPEFMIL	Proximity Helmet Shroud NFPA 1971 - Current Ed.
48NC9384180	Proximity Helmet Cover NFPA 1971 - Current Ed.
48HP2PFSC	Flannel Face Shield Cover NFPA 1971 - Current Ed.
48SPDBC	Proximity Suspenders NFPA 1971 - Current Ed.
48BT6220_	Boot, 16in Rubber Pull-on, ARFF, NFPA 1971, Current Edition for Structural Fire fighting, Proximity Fire fighting, and Liquid Splash/Hazardous Material Emergencies, and CSA Z195-14 for Protective Footwear

Available on



SP47W1-17-D-0028



Schedule 84 GS-07F-074BA

“Right Away - Yours”

Contract Availability



FEDMALL

GSA ADVANTAGE

Air Department Essentials



2473901000



45S6730







45S14685



71320132831



620ALAA48

Part Number	Description
482410FDW	 Wand, Flight Deck, LED, 4 Colors Red, Green, Yellow, Blue
43HST125	Adhesive Lined Heat Shrink Tape 1inW x 0.8 thick x 25ft L, Black
620ALAA48	Battery, AA, Alkaline, 48 per pack, Reclosable
2473901000	Classic Ear Plugs (200 per pack) Priced per 200
45S6730	Tape, Reflective, 2in x 10yds, White * Minimum of 2 Rolls
45S14685	Tape, Reflective, 2in x 10yds, Orange * Minimum of 2 Rolls
7134X5012	Air Hose, 3/4in x 50ft -1/2in QD, Red
71320132831	Air Hose, Rubber, Coupled, Red, 3/8in x 50ft
33710148	Stencil Set, 92pc., Letters & Numbers, Brass, 1in
33710151	Stencil, Set, 92pc., Letters & Numbers, Brass, 2in
33710153	Stencil Set, 92pc., Letters & Numbers, Brass, 3in
48K12FD	Rescue Saw 14in
48TLDB12	Rescue Saw Blade, 12in
48TLDB14	Rescue Saw Blade, Diamond, 14in
458BLKW	Benchmade Rescue Hook, 6.5", FB Soft Sheath
4819820157	 Cutter, Rescue, Seat Belt W/Handle
48T790	 Blades for Rescue Seat Belt Cutter (2 blades / 4 Shims per bag)
48L471	 Aviation Crash and Rescue Tool Kit (CVN/LHA/LHD/LPD)
48CTRSB	Crash Tool Roll by Rayco with Tool Roll Bag (CG/DDG/FFG)
45DH15022001	Power Hawk Rescue Kit, Super Hornet



48K12FD



48TLDB12
48TLDB14



Stencil Sets



Rescue Equipment



2 & 3 Seat Fly Benches



2 Seat
Length 40.25"
Width 25"
Height 34"



55B3F1 Series

COLOR OPTIONS

VINYL

Black, Red, Purple, Navy Blue, Royal Blue, Green

POWDER COAT (Box Frame)

Navy Gray, Black, Red, Standard Beige, White

(Contact us for custom non-standard color options)



3 Seat
Length 60.50"
Width 25"
Height 34"

Aviation Crash and Rescue Tool Kit

48L471 



Kit Includes:

- Metal Cutting Saw 16" Blade
- Aircraft Cable Cutter - Cuts 1/8" to 1/4" Capacity and 14" Long
- Lineman's Pliers 8" Long
- Hack Saw Frame - Adjusts From 8" to 12", Faces 4 Ways, Adjusts 90°
- 3 Hack Saw Blades - Hard Toothed Silver Steel
- Adjustable hook and loop fastener at sleeve cuffs
- Grappling Hook & Rope - 52" Sling
- 2 Philips Head Screwdrivers - 6" and 8"
- 2 Slotted Head Screwdrivers - 6" and 8"
- 3 Wooden Plugs
- Vise Grip Wrench - 10" Long
- Serrated Edge Hand Axe - 15" Long with Handle Insulated for 20,000v
- Safety V Blade Rescue Knife
- Weather-resistant, Mildew-resistant, Rubber-Coated Nylon Hi-Visibility Yellow Carrying Case



"Right Away - Yours"

Contract Availability



FEDMALL



GSA ADVANTAGE

4 Color Flight Deck Wands



482410FDW



Specs:

- LED Lamp
- 4 Color Filters (blue, yellow, red, green)
- Polycarbonate Lens
- One-handed Safety Switch
- FOD-proof screw
- Requires 4 AA batteries
- Weight with batteries: 8.2 oz
- Length: 12.50"

FL1 STANDARD	HIGH
	64 LUMENS
	12h 0mins
	118m
	3459cd
	IPX7

Ratcheting Tie Down Straps

Part Number	Description
459690000230	Tie Down Straps, Ratcheting, 2" wide x 30', 4000 lbs Work Limit with S/S Swivel Snap Hook, 10,000 lb Break Strength
459690000430	Tie Down Straps, Ratcheting, 4" wide x 30', 5000 lbs Work Limit with S/S Swivel Snap Hook, 20,000 lb Break Strength



Additional Sizes and Strengths available. Contact Rayco Supply for details.



AVIATION

80R-14



Part Number	Description	Part Number	Description
944271	Speed Handle, 3/8in	64405	Dial Torque Wrench 1/2in Drive 0-250 lb
641490MTN	Cable Cutter, 14in	640390MNE	Bolt Cutters 36in
945760	Pliers, 6in (Slip Joint)	945380	Pliers, 10in (Slip Joint)
82075	Pliers, 8in, Side Cutting	58614T	Pliers, 8 1/2in, Locking
945764UR	Pliers, Lineman	140GL10BULK	Pliers, Rib-Joint, Water Pump 10in
945102	Pliers, Long Nose (Needle Nose)	69410	Pound Ball Pein Hammer, 1-1/2lb
70189	Drift Punch, 8in	18380950	Hacksaw Frame, 10in
645960A2	Crash/Fire Axe	6458875A52	Pry Bar, 36in
64PPB60	Pry Bar, 60in	065W30	Crow Bar, 26in
934842	Socket Set, 1/2in Drive, 57pc	916452	Socket Set, 3/8in Drive, 20pc
923805	Ratchets, 1/2" Drive	923837	Extension, 3/8" Drive, 12in
944131	Extension, 1/2" Drive, 6in	94257	Adapter, 1/4in Hex dr to 3/8in dr
923845	Adapter, 3/8in dr step down to 1/4in dr	12918	Breaker Bar, 1/2in Drive
947500	Socket, 3/8in, 1/2in Drive, 12pt	946662	Socket, 7/32 Hex Bit, 3/8" Drive
944371	Socket, #2 Phillips tip 3/8" Drive	942664	Socket, #30 Torx tip 3/8" Drive
947186	Screwdriver Phillips #2	947187	Screwdriver Phillips #3
941577	Screwdriver, Flat Tip, 3/16" Tip, 6"	947197	Screwdriver, Flat Tip, 5/16" Tip, 10"
946545	T-Handles 7/32 Hex Wrench	944605	Wrench, 12" Adjustable
944603	Wrench, 8" Adjustable	48DC2510 	Wrench, Firehose, Spanner
45S600R	Battery Powered Megaphone	45N352	Safety Flashlights - Explosion Proof
643HFV87	Drill Driver, Electric, Portable	55LFH1016	Ladder 16 Ft Fiberglass Type 1A
48R631	Halligan Tool	RA5958388	Jack, Hydraulic Starter Kit, 10 Ton, w/ metal case/ tool box
0981102008 	Delta Vest Style Positioning Harness, Back/Side D-Rings, Tongue Buckle, Universal	0981246011 	EZ Stop Shock Absorbing Lanyard, 6 ft, Self-Locking, 310 lb Capacity, 1 Leg, 310 lb [Max]



"Right Away - Yours"

Contract Availability



FEDMALL



GSA ADVANTAGE

Aviation Tools

Part Number	Description
11974A	Ratchet, Flex, 3/8in Drive
10972	Ratchet, Teardrop, 1/4in Drive
12917	Breaker Bar, Flex, 1/2in Drive
916452	Socket Set, 20pc, 3/8in Drive, 6 Point SAE
15530	Socket Set, 18pc, 1/2in Drive, 6 Point SAE
565K156	Punch Set, Self Centering, 9 pc , 1-4in -1in
4670933	Magnetic Retrieving Tool, 16-3/4in to 26-3/4in
45HTS2	Inspection Mirror, 3-1/4in Diameter, Telescoping
64J47303	 302 Piece 1/4", 3/8" & 1/2" Drive Full Polish Finish Deep Well Socket Set
510214UR	Tool Bag, 14in No 8, Canvas

* See our Engineering Section for more tools and Welding Items



Ratchet



Breaker Bar



Socket Set



Punch Set



Retrieving Tool



Inspection Mirror



Tool Bag





64J47303



SWENCH[®] MANUAL IMPACT WRENCHES



Part Number	Description
6419817211	 ABE-C1 Catapult Swench Kit #1, QTY-2 of Model 750, 20" Extension (3/4" Drive - Tubular)
6419817212	 ABE-C2 Catapult Swench Kit#2, QTY-2 of Model 750
6419817213	 ABE-A1 Accumulator Swench Kit, Model 1000, Model 750, Offset 4-1/4" (1" Drive), Offset 3-1/4" (3/4" Drive), 7" Extension (1" Drive - Tubular), 6" Extension (3/4" Drive - Tubular)



“Right Away - Yours”





Contract Availability



FEDMALL

GSA ADVANTAGE

AVIATION

Part Number	Description
4334097051501	Vacuum, Pneumatic, 15Gal., Pad-Eye Vacuum System w/Vertical Venturi
469627210	 Vacuum, Industrial Wet/Dry Vac, 16 Gallon, 120V, 6.25 HP, Nozzle Accessories
6779034000	 Filter, HEPA, For Shop-Vac 469627210
4661472	Vacuum, Pneumatic, Raptor Vac Backpack Style, 1.5 Gal
48915561001	  Nozzle Kit, Replacement Parts for Type SB Stainless Steel
456MFSM36	 Magnetic Floor Sweepers, 11.8 lb, 36" Sweeping Width



15 Gallon Stainless Steel Flight Deck PadEye Vac

Features:

- High Efficiency Vertical Venturi designed for use with ship LP Air Systems.
- FOD Free for Flight Deck use – no bearings.
- Automatic Shut-Off: Float ball and cage for wet use.
- Tank: Stainless Steel with triple ribs.
- Vacuum Inlet: Locking to prevent accidental contamination.
- Dolly Cart: Low Profile Tip Resistant with handle.
- QAV technology reduces noise (does not exceed 80 dba).
- 25' crush-proof hose with locking end and swivel cuff.
- PadEye Extraction Wand and attachments for CVN and Amphibious class ships.
- Complies with SECNAVINST 5720.42, OPNAVINST 3750.6 Series and OPNAVINST 5102.1 Series, dated May 22, 2015.



Don't see what you are looking for?
Contact your Rayco Rep for more information regarding the products in this category.



Conex Boxes and Lockers



* Customized Option *

★ Multiple Sizes and Varieties Available!! ★
Contact your Rayco Rep Today!!



Standard Lockers



Single Tier
Double Tier
Triple Tier
Four Tier
Box Style

Bridge Lockers



Ventilated Lockers
49TA50HT422478VE

“Right Away - Yours”

Contract Availability



DAMAGE CONTROL

Structural Turnout Gear

Comfort Chinstraps (optional)
Curved design for better fit and less irritation

Articulating Drag Rescue Device
Adjusts to maintain equal leverage on a downed firefighter even when pulling from an angle (patented)

New Shoulder/Arm Pattern
Increased arm mobility when reaching and more even weight distribution across shoulders

Forward Flex™ Sleeve
Patented design eliminates undesirable sleeve retraction when reaching up or forward

Continuous 360° Protection
Outer shell, moisture barrier, and thermal barrier overlap at coat facings, collar linings, and pant fly to give uninterrupted protection

Large Inspection Ports
Patented feature allows for easier inspection of thermal liner and moisture barrier

Standard snap tab
Keeps shell and liner aligned

Full Access Fly
Easier donning and doffing

Full Range of Motion Crotch
Patented U-shaped design and diamond shaped insert allow greater leg mobility (patented)

Reshaped Neck/Collar
Contoured fit for more natural comfort around the neck and across the shoulders

Kinetic Kut™ Styling
Significantly reduces hem rise and sleeve retraction, allowing for greater range of motion and protection (patented)

Single Seam Sleeves
Innovative design eliminates second seam, reducing wear point

Waterproof Wristlets
Double-layer tough and durable Nomex® wristlets with continuous moisture barrier provide a liquid seal at the wrist (patented)

Hybrid Long Tabbed Wristlets
Durable and comfortable thumb locator option doesn't interfere with glove donning

Double Stitched Trim
Higher durability

Tails™ System
Reduces weight, increases range of motion and eliminates bunching when bending forward. Also increases visibility from behind and improves torso ventilation

New Liner Attachment
More robust attachment, easier to remove liner from shell

Low-waist Comfort Pant
Increases mobility at waist, reduces weight, and allows for more ventilation
- feels like a pair of jeans
- wears like a pair of jeans
- rides like a pair of jeans

Seam Guards
Placed over trim threads at high-abrasion areas on the coat and pant to reduce wear (patented)

Better Pant/Boot Interface
Easier to store pants on newer style boots



MORNING PRIDE



TO ORDER

Call: 1-757-431-0698

email: RAYCO@RAYCOSUPPLY.COM

Visit our website: RAYCOSUPPLY.COM

DAMAGE CONTROL

Honeywell

Coats

Part Number	Description
48GSARAY00113	STRUCTURAL TAILS COAT - 62V3 GOLD
48GSARAY00116	STRUCTURAL TAILS COAT - 42I3 BRONZE
48GSARAY00121	STRUCTURAL TAILS COAT - 42Z3 BRONZE

Pants

Part Number	Description
48GSARAY00112	STRUCTURAL TAILS PANT - 62V3 GOLD
48GSARAY00117	STRUCTURAL TAILS PANT - 42I3 BRONZE
48GSARAY00120	STRUCTURAL TAILS PANT - 42Z3 BRONZE



Ben 2 Helmet



Lite Force Helmet

All Items Available on



Super Glove

- Bubble-Flex Finger and Knuckle Construction
- Air Spacer Thermal Architecture
- Ultra-Thin, Ultra-Strong Top Grain Kangaroo Leather on Glove Back
- True 3D Hand-Shaped Styling
- Black Digiroot Digital Kangaroo Grip Palms and Fingers
- Black Eversoft Cowhide Cuffs Crosstech® Moisture Barrier and Kevlar/Nomex Thermal Liner

Helmets

Part Number	Description
48GSARAY00128	Structural Helmet, Ben Low Rider, Black, Standard
48GSARAY00129	Lite Force Low Rider, Yellow, Standard

Gloves

Part Number	Description
48GLSGKCW	Super Glove Wristlet
48GLSGKCG	Super Glove Gauntlet

Sizes: 2XS, XS, S, M, L, XL, 2XL, 3XL

“Right Away - Yours”

Contract Availability



DAMAGE CONTROL

Morning Pride Pro Fit Pant

Take comfort to the next level with our new Morning Pride® Pro Fit Pant. This new design combines the best of both worlds – the tailored professional fit you have come to expect from Morning Pride, along with improved mobility through a more modern fit. It's still a Morning Pride pant, so you can trust the high quality and durability, and of course find a rich selection of optional features.

The innovation on the Pro Fit pant isn't just that we lowered the front to sit at the hips, for the most preferred fit today. We also realigned the rest of the pant for a less bulky crotch, a properly aligned knee position that eliminates knee roll, and reduced cuff retraction. You'll feel the difference in the ease of movement, eliminating stress and making your job easier.

The Morning Pride Pro Fit is available in all fabric composites, with most options offered in the current Morning Pride TAILS line. The base garment comes standard with the following:

- Kevlar®-lined bellows pockets with 3:1 hook and pile, and easy grip
- Half-angle cuffs with Ara-shield® trim
- Narrow fly with hook and pile, and reverse hook on tab
- Take-up straps

NFPA 1971 certified

Lower waist in front while keeping enough coverage in the back (NEW)

Full range of motion crotch

Horizontal seaming to increase flexibility and movement (NEW)

Pleated knees for added flexibility (NEW)

Seam Guard placed over trim threads at high-abrasion areas of pants to reduce wear (patented)

Reduced cuff retraction (NEW)



Honeywell



DAMAGE CONTROL



Honeywell Morning Pride Gear Shield helps to significantly reduce the amount of dangerous, potentially **cancer-causing toxins** that can reach your skin.



Head Shield

The MaskMate™ Hood with STEDAIR® PREVENT blocks 99.9% of particulates, protecting the vulnerable areas on the face and neck (compared to 20-40% for conventional, non-barrier hoods). It is also breathable, soft, and flexible while providing high levels of thermal insulation.



Arm Shield

Dual coverage at the wrist: A contoured 360° shingle cuff prevents particles from getting to the wrist, while still maintaining wrist flexibility. An extension of the moisture barrier from the water well into the glove greatly reduces those particles that do pass the cuff from depositing on the arms.

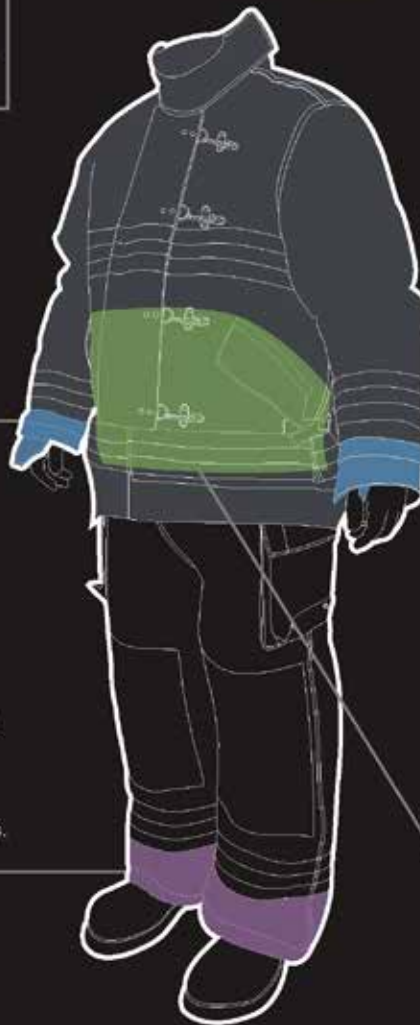

Heat Release Liner

The centerpiece of our Honeywell Morning Pride Gear Shield package is our Heat Release Liner. While the Arm Shield, Leg Shield, and Core Shield features all provide extra particulate protection, they also trap more body heat compared to current gear. The Heat Release Liner, with its patent-pending installation of multiple vents, allows for heat trapped inside the liner to escape faster upon exiting the fire.



Leg Shield

A patented telescoping water dam at the ankle cinches around the boot and adjusts up and down with your movement to significantly reduce the deposition of particles higher on the legs.



Core Shield

An angled band with elasticized edges comfortably conforms to your midsection when your coat is closed to reduce particle ingress at the coat and pant interface. The front of the Core Shield uses Nomex® versus a thermal liner to lower heat build-up and requires no extra steps when donning and doffing.

“Right Away - Yours”

Contract Availability



FEDMALL













GSA ADVANTAGE

DAMAGE CONTROL



Part Number	Description
4819813396 	Hood, Firefighting, PBI Gold *NFPA Certified (PAC IX)
48191202419 	Hood, Antiflash, Grey, (General Quarters) *NFPA Certified (PAC IA-19)
48014627670 	Flash Hood, Black, PBI *NFPA Certified (PAC IX)
RB2679661	Anti - Flash Gloves; Universal Size



Part Number	Description
76NAVY2K70SR 	FPG One Piece, 2k Navy Small Regular, NFPA1971 & 29CFR (Short and Long Available)
76NAVY2K70MR 	FPG One Piece, 2k Navy Medium Regular, NFPA1971 & 29CFR (Short and Long Available)
76NAVY2K70LR 	FPG One Piece, 2k Navy Large Regular, NFPA1971 & 29CFR (Short and Long Available)
76NAVY2K70XLR 	FPG One Piece, 2k Navy X-Large Regular, NFPA1971 & 29CFR (Short and Long Available)
76NAVY2K70XXLR 	FPG One Piece, 2k Navy XX-Large Regular, NFPA1971 & 29CFR (Short and Long Available)
76NAVY2K703XLR 	FPG One Piece, 2k Navy 3X-Large Regular, NFPA1971 & 29CFR (Short and Long Available)
48BT2600_ 	Boot, FireFighting, Pull On Bunker, Steel Toe, NFPA 1971 & NFPA 1992, Sizes 3 - 16 (half sizes 5.5 - 13.5 available)
4819821499 	Steamblock FF Gloves, Medium
4819821497 	Steamblock FF Gloves, Large
4819821500 	Steamblock FF Gloves, X-Large
48FXA1TL	Helmet, Fire Fighting, w/Traklite System



* FXA-1TL Helmet *



48FXA1TL
*Specify color when ordering



4819821499



48BT2600_

* Two Piece Turn Out Suits Available - Custom Order
* Please Contact Us with Sizes Required



DAMAGE CONTROL

Part Number	Description
76CEB2	Coverall, 9oz, Deluxe

- One piece, topstitched, lay-flat collar
- Two-way concealed Nomex® taped brass break-away zipper
- Concealed snap at top of zipper at neck
- Mandarin style stand up, two way safety collar
- Concealed snap closure on sleeve cuff
- Side vent opening with snap closure
- Two front swing pockets are topstitched and lined
- Two chest pockets with flaps and concealed snaps
- Two patch hip pockets have single concealed snap closure
- Left Sleeve pocket
- Deep-pleated action back
- Elastic waist inserts
- Rule pocket on right leg



76CEB2

Available Colors



* When Ordering Specify:

Chest Measurement: 28" - 72"
Length: Short, Reg, Long, X-Long

Short: 5'3" - 5'7" • Regular: 5'7" - 5'11" • Long: 5'11" - 6'3" • X-Long: 6'3" - 6'5"

Excel FR® Flame-resistant, 9 oz. Twill,
100% Cotton

Arc Rating ATPV 10.6 calories/cm2

Part Number	Description
48JSNV1590MR	Red ENG Coverall, M - U.S. Navy (38 - 40)
48JSNV1590LR	Red ENG Coverall, L - U.S. Navy (42 - 44)
48JSNV1590XLR	Red ENG Coverall, XL - U.S. Navy (46 - 48)
48JSNV1590XXLR	Red ENG Coverall, XXL - U.S. Navy (50 - 52)

Alpha Size	Neck	Sleeve	Chest
S	14-14.5	33.5	34-36
ST	14-14.5	35	34-36
M	15-15.5	34	38-40
MT	15-15.5	35.5	38-40
L	16-16.5	34.5	42-44
LT	16-16.5	36	42-44
XL	17-17.5	35	46-48
XLT	17-17.5	36.5	46-48
2XL	18-18.5	35.5	50-52
2XLT	18-18.5	37	50-52
3XL	19-19.5	36	54-56
3XLT	19-19.5	37.5	54-56
4XL	20-20.5	36.5	58-60
4XLT	20-20.5	38	58-60
5XL	21-21.5	37	62-64
5XLT	21-21.5	38.5	62-64

* Short, Regular, Tall, X - Long Lengths Also Available *



48JSNV1590MR

"Right Away - Yours"

Contract Availability



FEDMALL

GSA ADVANTAGE

DAMAGE CONTROL

Hoses, Pumps, Nozzles, Straps

Part Number	Description
48CDHT1500SS	Delta Fire Hose Tester
482BE10YDN	P-100 Pump, Portable
48DC2565	Fire Hose, 1-1/2" x 25' NPSH Fitting; MIL-SPEC
48DC2542	Fire Hose, 1-1/2" x 50' NPSH Fitting; MIL-SPEC
48DP17600OBR1	Fire Hose, 1-3/4" x 50' NPSH Fitting; MIL-SPEC
48DC2543	Fire Hose, 2-1/2" x 50' NST Fitting; MIL-SPEC
48DC2553	Fire Hose, 4" x 50' NPSH Fitting; MIL-SPEC
71H24580112150	Hose, AFFF 1-1/2" X 150 FT IAW MIL-H-24580 M X F Coupled NPSH Brass Fittings
71H2458011250	Hose, AFFF 1-1/2" X 50 FT IAW MIL-H-24580 M X F Coupled NPSH Brass Fittings
48DP15600PUX50	Potable Water Hose, 1-1/2" x 50' NPSH Fitting
48DP25600PUX50	Potable Water Hose, 2-1/2" x 50' NPSH Fitting
48FHS36RWC	Fire Station Straps, 1" *Clips sold separately
48FHSECSS	Clips, ALL SS Hardware for Fire Station Straps
48DC2513 (125 GPM)	1-1/2" Vari Nozzle, 125 GPM
48DC2512 (95 GPM)	1-1/2" Vari Nozzle, 95 GPM
48DSFN	2-1/2" Vari Nozzle, 250 GPM
48B100N	Wye Gate, Navy Brass
48DC2510	Aluminum Combo Spanner Wrench
48K48	Spanner Wrench Holder
23321072	1-1/4" - 3" Adjustable Hook Spanner Wrench

DELTA HYDRO 48CDHT1500SS INCLUDES:

- All STAINLESS 1-1/2in manifold
- All STAINLESS heavy duty cart with wheels
- Powerful 1.7 HP INDUSTRIAL TEFC (total enclosed fan cool) Motor
- Electrical connection: 110/120 V
- 1.5in Brass NPSH Check Valve
- Check valve assemblies also available in Aluminum
- Delivers up to 500 PSI (3447 kPa) pressure
- 1-1/2" NST female swivel inlet connector
- In-line filter included on all models
- Complies with NFPA standards



48CDHT1500SS

482BE10YDN P-100 Pump

- 4 Cycle, 10HP Engine
- 3in NPT Suction
- 1-2 1/2in NPT or 2-1 1/2in NPT discharges
- Bronze Impeller and Wear Rings
- Stainless Steel Impeller shaft
- Throttle, Roll Cage, Exhaust Primer



482BE10YDN



48DSFN



48FHSECSS



48FHS36RWC



48K48



48B100N

48DC2513

48DC2510



23321072



48DC2542



TO ORDER

Call: 1-757-431-0698

email: RAYCO@RAYCOSUPPLY.COM

Visit our website: RAYCOSUPPLY.COM

DAMAGE CONTROL

Extinguishers



Part Number	Description
48431999	Extinguisher, CO2, 15# MILSPEC
4879456	Mount Bracket for 48431999
4815832	Extinguisher, PKP, 18# MILSPEC w/ bracket
4815665	Mount Bracket for 4815832
4825425	Extinguisher, PKP, 27# MILSPEC w/ bracket
4825428	Mount Bracket for 4825425
48250N	Extinguisher, AFFF 2-1/2 Gallon
960430	Extinguisher, Fresh Water 2-1/2 Gallon
408466112	Extinguisher, ABC, 5lb
47A61361	Extinguisher, Halon 1211 17lb
48429293	Horn and Hose Assembly, 4ft OAL
48551890	Horn and Hose Assembly, 7 ft OAL
48432011	Belly Band End, Metal
48429516	Belly Band Clip, Plastic
RB44610105	Tamper Seals, Box of 100
453MN050DG	PKP Label *10/ pack
453MN051DG	CO2 Label *10/ pack
453MN052DG	AFFF Label *10/ pack



4825428



4879456



RB44610105



453MN051DG



453MN052DG



453MN050DG

*** Rayco Supply does not refill extinguishers ***

Contact Duncan Munro at Virginia Industries for the Blind
757-206-2842 or Duncan.Munro@vibonline.org

Sprinkler Heads

Part Number	Description
48495541328	Sprinkler Head Type G
48492101001	Sprinkler Head Type B, Upright
48492111001	Sprinkler Head Type B, Pendant



48495541328



48492101001



48492111001

Contract Availability



FEDMALL

GSA ADVANTAGE

“Right Away - Yours”

DAMAGE CONTROL

AFFF Foam

QPL & C6
CERTIFIED



6% MILSPEC

Part Number	Description
4820780	AFFF, 6% (Type 6) MILSPEC 5 Gallon Pail
4820781	AFFF, 6% (Type 6) MILSPEC 55 Gallon Drum
4820782	AFFF, 6% (Type 6) MILSPEC 265 Gallon Tote



QPL & C6
CERTIFIED



3% MILSPEC

Part Number	Description
4820770	AFFF, 3% (Type 3) MILSPEC 5 Gallon Pail
4820771	AFFF, 3% (Type 3) MILSPEC 55 Gallon Drum
4820772	AFFF, 3% (Type 3) MILSPEC 265 Gallon Tote

These AFFF products are also Available on both



SP47W1-17-D-0028



Schedule 84 GS-07F-074BA



Part Number	Description
4890050	 AFFF Pail & Drum Wrench



265gal Tote



TO ORDER

Call: 1-757-431-0698

email: RAYCO@RAYCOSUPPLY.COM

Visit our website: RAYCOSUPPLY.COM

DAMAGE CONTROL

Part Number	Description
486525960	 Aerotest Simultan HP&P Complete Kit
485454106	Alkaline Battery Pack for PHD-6
485454107	Rechargeable Li-Ion battery Pack for PHD-6
4854541031	Li-Ion Battery Charger for PHD-6
485405K0502	Cal Gas Operational Calibration Safety Check Kit - PHD Ultra Calibrator Adapter, PHD-6 Calibration Cover, Regulator, 1.0 LPM, #70, PHD Ultra/PHD6 Calibration Kit Case, Calibration Kit Label, Fuel Resistant Tubing (per foot), 58-Liter Gas Cylinder, CO 50PPM/H2S, 25 PPM, and a Weather Proof Carton
485454102	Continuous Sample Draw Pump for PHD-6

PHD6 Sensors

Part Number	Description
48549044E	Cal Gas - 58 Liter (For Direct Purchase Only)
4819806876	Cal Gas - 34 Liter (For Direct Purchase Only)

The following have been discontinued with limited quantities still available. Contact us for availability.

48545401	CO, Carbon Monoxide
48545402	H2S, Hydrogen Sulfide
48545480	LEL Combustible
48545490	O2, Oxygen
48545414	Duo-Tox CO/H2S

Aerotest Simultan HP&P Complete Kit SHIPBOARD REQUIREMENT

486525960



Features:

- Quick and easy application
- All components of the draeger aerotest navy are housed ready for use in a handy carrying case
- Allows the quantitative measurement of a variety of potentially harmful substances: carbon monoxide, carbon dioxide, water vapour and oil, as well as other contaminants.
- No battery pack

Includes:

- Deluxe Carrying Case
- Instruction Booklet
- Pressure Reducer
- Measuring Device for 4 Tubes
- CGA 347 Adapters
- Tube Opener
- accuro Pump
- Spare Parts Kit
- Dräger-Tubes

Honeywell

The Honeywell BW™ Ultra is a five-gas detector from Honeywell that is designed specifically for sampling and monitoring confined spaces, before and after entry. It benefits from unmatched sensor technology, visibility on gas readings, comfort, and connectivity – even in most extreme working conditions. The Honeywell BW™ Ultra simultaneously detects the four gases you're required to monitor in confined spaces. Plus there is a fifth sensor for the gas of your choice. This way you can add a fifth level of protection for your confined-space entries.

Honeywell BW™ Ultra



Contract Availability

“Right Away - Yours”



FEDMALL



GSA ADVANTAGE

DAMAGE CONTROL

Dräger



484056443



488326368

48QDTK		Kit, Quarterly Dräger Tubes, Box
--------	--	----------------------------------

Rayco Supply's Quarterly Dräger Tube Kit Includes:

Two Packs Each of the Following:

- Phosgene 0.02/A
- Ethylene Oxide 25/A
- Vinyl Chloride 0.5/B
- Carbon Monoxide 10/B
- Hydrocyanic Acid 0.5/A
- Hydrochloric Acid 1/A
- Hydrogen Sulfide 1/D
- Nitrogen Dioxide 0.5/C
- Carbon Dioxide 0.1%/A
- Hydrocarbon 2 2/A 2-24MG/L
- Hydrogen Flouride 0.5/A
- Sulfur Dioxide 1/A



Part Number	Description
45X53248	Filter Element, Fluid
45X53678	Filter Element, Fluid
45GG192453	CO Indicator
45SK5306NA	Seal Replacement Parts Kit

All DRAGER Detection Tubes are sold in packages of 10





Part Number	Description
484056443	Hard Sided Accuro Pump Kit
488326368	Pac 6000 H2S Monitor, 0.4 - 100 ppm
488103061	Water Vapor 20/A-P 20-500, Aerotest
488103111	Oil 10 PN 5 MG/M3, Aerotest
486728521	Carbon Dioxide 100/A-P, Aerotest
486728511	Carbon Monoxide 5/A-P, Aerotest
48CH20601	Carbon Monoxide 10/B
48CH20501	Ammonia 5/A 5-700 ppm
48CH24301	Chlorine 0.2-30 PPM
486728241	Ethylene Oxide 25/A
488103601	Hydrocyanic Acid 0.5/A
48CH30301	Hydrogen Flouride 1.5/B
488101831	Hydrogen Sulfide 1/D
488103581	Hydrocarbon 2 2/A 2-24MG/L
48CH29501	Hydrochloric Acid 1/A
48CH30001	Nitrogen Dioxide 0.5/C
488101741	Benzene 15-420 PPM
486733181	Ozone 0.05-1.4 PPM
488101521	Phosgene 0.02/A
48CH31701	Sulfur Dioxide 1-25 PPM
488101661	Toluene 5-300 PPM
48CH21101	Trichloroethane 50-600 PPM
488101721	Vinyl Chloride 0.5/B
48CH23501	Carbon Dioxide 0.1%/A
48CH22901	Acetone 100-12000 PPM
48QDTK	Kit, Quarterly Dräger Tubes, Box

In addition to the most popular dräger tubes listed above, all other tubes are available through Rayco Supply, Inc.



DAMAGE CONTROL

Overboard Discharge Assemblies

Part Number		Description
5194741973		Overboard Discharge Assembly Coupler Double Male Hose Brass 4" MNAVY x 2-1/2" MNST (usually CVNs / LSDs)
487DISCHARGE		Pipe Mating for Overboard Discharge Fitting (usually CVNs / LSDs)
5194741973MOD		Overboard Discharge Assembly, 4in reduce to 2-1/2in Plug Modified to have 4in FNPSH fits existing male pipe connection (usually DDGs / LHDs)
48OBDF		Overboard Discharge Assembly, Flanged 4in- 2-1/2in with Cap (Please specify bolt hole pattern when ordering)



5194741973



5194741973MOD

Part Number	Description
48DC2522	2-1/2" FM NST x 2-1/2" Male NPT Swivel Brass Adapter Rocker Lug
48DC2523	1-1/2" FM NPSH x 1-1/2" FM NPT Swivel Brass Adapter Rocker Lug
48DC2524	2-1/2" FM NST x 2-1/2" FM NPT Brass Adapter Rocker Lug
48DC2525	1-1/2" NPSH Double Male Brass Adapter Rocker Lug
48DC2526	2-1/2" NST Double Male Brass Adapter Rocker Lug
48DC2527	1-1/2" NPSH Double Female Brass Adapter Rocker Lug
48DC2528	2-1/2" NST Double Female Brass Adapter Rocker Lug

Part Number	Description
48DC2529	1-1/2" NPSH Brass Hose Plug and Chain Rocker Lug
48DC2530	2-1/2" NST Brass Hose Plug and Chain Rocker Lug
48DC2531	1-1/2" NPSH Brass Hose Cap and Chain Rocker Lug
48DC2532	2-1/2" NST Brass Hose Cap and Chain Rocker Lug
48DC2533	1-1/2" Male S/B x 1-1/2" FM NPSH Swivel Adapter Brass Rocker Lug
48DC2534	2-1/2" Male S/B x 2-1/2" FM NPSH Swivel Adapter Brass Rocker Lug



Don't see what you are looking for?

Contact your Rayco Rep for more information regarding the products in this category.

"Right Away - Yours"

Contract Availability



FEDMALL



GSA ADVANTAGE

DAMAGE CONTROL

Part Number	Description
RB3332224	Navy Ram Fan Water Driven Kit, Includes: 1 - WF20 Blower with 1.5in Male Connections 2 - WF20 10in Adapters w/ Snap Lock 4 - WF20 Neoprene Coated Duct (10in x 15ft)
57WF200250	Adapter Double Female, NPSH
57WA2300	Strainer for Adapter. For Use With 57WF200250



RB3332224



57WF200250



57WA2300



48WSOA

Part Number	Description
48WSOA	 Water/Smoke Overboard Apparatus *MFR min of 5

Part Number	Description
48DW5010PTN	 RDD (Rapid Deployment Ducting) Hose Assy Kit, Air Duct 10" x 50', and 48" Storage Bag *MFR min of 5
48DW3010PTN	 RDD (Rapid Deployment Ducting) Hose Assy Kit, Air Duct 10" x 30', and 36" Storage Bag *MFR min of 5
48EF20PTN	 Adapter, 10" RDD (Rapid Deployment Ducting) End, Female
48EM20PTN	 Adapter, 10" RDD (Rapid Deployment Ducting) End, Male
48BA20PTN	 Adapter, Navy Ram Fan Blower Adapter; RDD Adapter Flange 10" (Fits Old and New Style 10" Duct)
48LP20PTN	RDD (Rapid Deployment Ducting) Latch Kit, (includes 2 ea. Latches & 2 ea. Retaining Pins)
48SN20PTN	 RDD (Rapid Deployment Ducting) End Ring Mounting Screws and Nuts (includes 8 ea. 1/4" - 20 S.S Nylock Nut)
48R5020PTN	 10" x 50' RDD (Rapid Deployment Ducting) with Storage Bag, storage size is 48" (EF20: Female End and EM20: Male End Sold Separately)
48R3020PTN	 10" x 30' RDD (Rapid Deployment Ducting) with Storage Bag, storage size is 36" (EF20: Female End and EM20: Male End Sold Separately)

48R5020PTN



48R3020PTN



48BA20PTN



DAMAGE CONTROL

Deck Drain Styles

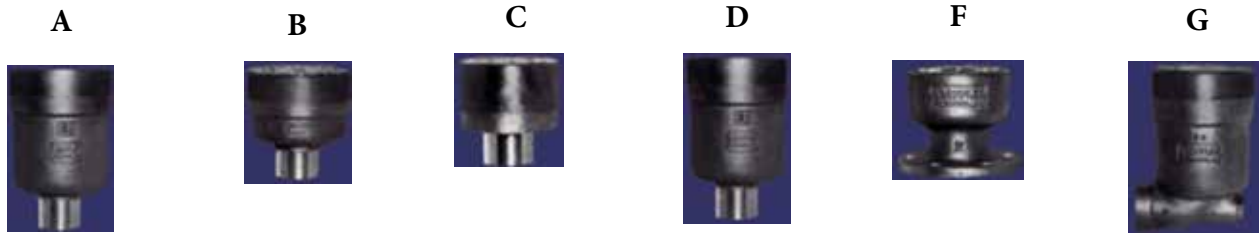

Strainer / Cover Styles

Type A, Type B & Type G



Type C



Type D, Type H



Part Number	Description
48DC2536	Deck Drain, 1-1/2in. Bronze Type A
48DC2536S	Deck Drain Cover, 1-1/2in. Bronze Type A
48DC2538	Repair Kit, Deck Drain, 1-1/2in. Bronze Type A
48DC2537	Deck Drain, 2in. Bronze Type A
48DC2537S	Deck Drain Cover, 2in. Bronze Type A
48DC2539	Repair Kit, Deck Drain, 2in. Bronze Type A

Part Number	Description
48DC2575	Deck Drain, 3in. Bronze Type A
48DC2547S	Deck Drain Cover, 3in. Bronze Type A
48DC2547	Repair Kit, Deck Drain, 3in. Bronze Type A
48DC2545	Deck Drain Screws (Monel), Box of 50
48DC2535	Deck Drain T-Wrench



Deck Drain Repair Kits are recommended when it is not necessary to replace entire deck drain body.

“Right Away - Yours”

Contract Availability

FEDMALL
A! GSA ADVANTAGE

DAMAGE CONTROL

DC & Shipboard Items



Part Number	Description
48DC2556	25 Ft Sounding Tape
48DC2517	50 Ft Sounding Tape
48DC2518	75 Ft Sounding Tape
48DC2572	100 Ft Sounding Tape
48DC2517M	15m Sounding Tape (Metric)
48DC2519	20 Oz Plumb Bob
48DC2516	Water Indicating Paste

Part Number	Description
960001	Tape, Safety Marking, Red Vinyl 2in X 36in
482768	Spike, Wire Rope, Marlin 8in.
4827616	Spike, Wire Rope, Marlin 16in.



Part Number	Description
48DC2520	Dogging Wrench
488A	Wrench, Hatch 1-5/16" Single End Engineering Box of 6 each
486A	Wrench, Hatch 15/16" Single End Engineering Box of 6 each
48C34	Chain for Air Test Cap, 3/4in * 50ft Spool
4866234B	3/4in Brass Air Test Cap Rocker Lug
4866110121	1in Brass Air Test Cap Rocker Lug
48662112B	1-1/2in Brass Air Test Cap Rocker Lug



DAMAGE CONTROL

Flashlights & DC Tools



452410CY



452410CB





4890400



Streamlight Survivor



45N352

Part Number	Description
452410CY	 Stealthlight, Yellow LED
452410CB	 Stealthlight, Black LED
45N352	 FlashLight, Explosion Proof
4890540	Streamlight LED, Hi-Vis Orange, Right Angle, Alkaline
4890500	Survivor LED Rechargeable Flashlight, Orange
4890400	Charger, 5 Bank for Streamlight Survivor



645960A2

Product	Description
645960A2	Axe, Crash Fire, Head 3-1/2lb, Cutting Edge 4-9/16in, OAL 35-1/2in
48R631	Claw, Halligan, Entry Tool, 30", Standard
47940138	Pry Bar, 36in
640390MNE	Bolt Cutters, 36in



640390MNE



47940138



48R631

“Right Away - Yours”







Contract Availability

 FEDMALL

 GSA ADVANTAGE

DAMAGE CONTROL

Battle Lanterns & Upgrade Kits

Part Number		Description
RB1412901		Battle Lantern, Portable, Hand Held with Mounting Bracket Uses Incandescent Bulbs
4820B		Battle Lantern Bulbs, Box of 12
48BLLEDUK4W		White LED Upgrade Kit
48BLLEDUK2R		Red LED Upgrade Kit
48BLKITSWLED		Bulk Head Mounted Combined Conversion Kit- White LED Non-Rechargeable to Rechargeable
48BLKITSRLED		Bulk Head Mounted Combined Conversion Kit- Red LED Non-Rechargeable to Rechargeable
48BLKPRRLED		Portable Combined Conversion Kit- Red LED, Non-Rechargeable to Rechargeable
48BLKPRWLED		Portable Combined Conversion Portable Kit- White LED, Non-Re-chargeable to Rechargeable
48BLB65S		Battery, Rechargeable, Recyclable, 6 Volt



RB1412901



Part Number	Description
48BLK1TSDMS	Rechargeable Retrofit Kit, Battle Lantern, Bulkhead Mount To upgrade bulkhead battle lantern SYM 101.2 (non-rechargeable) to SYM 101.3 (rechargeable). Kit includes: Charger/control Module & Top Plate Assembly IAW MIL-DTL-16377/53d. (Complies with the revised Spec 53D) ** Requires (1) rechargeable battery, M16377/53-009; Not Included
48BLKPRDMS	Rechargeable Retrofit Kit, Battle Lantern, Portable To upgrade portable battle lantern SYM 100.2 (non-rechargeable) to SYM 100.3 (rechargeable). Kit includes: Charger/control Module & Smart Handle Assembly IAW MIL-DTL-16377/53d. (Complies with the revised Spec 53D) ** Requires (1) rechargeable battery, M16377/53-009; Not Included



LEDs







*Rayco Supply is the EXCLUSIVE Distributor for the Combined Rechargeable/
LED Battle Lantern Conversion Kits. *



DAMAGE CONTROL

Kits & Bags

Part Number	Description
48SGFDK1 	Flag Kit, Firefighting
48SGMSDK1 	Flag Kit, Main Space
48SGDCK1 	Flag Kit, Damage Control
48PGDCPPPK1	Portable Plugging and Patching Kit Bag Only
PGVDCPPPK2 	Portable Plugging and Patching Kit w/ all Items
48SGIET1 	Inport Emergency Team Flag Kit
48SGSBST1 	Shoring Tool Kit Bag #1 of 2
48SGSBST2 	Shoring Tool Kit Bag #2 of 2
48SGSBSP1 	Portable Pump Kit bag
48SGSBFFK1 	Firefighting Access Equipment Kit Bag
48SGSBI1 	Investigator Kit Bag
48SGSBAC1 	Adapter/ Connector Kit Bag
48SGSBDS1 	Desmoking Kit Bag #1 of 2
48SGSBDS2 	Desmoking Kit Bag #2 of 2
48SGSBDW1 	Dewatering Kit Bag #1 of 2
48SGSBDW2 	Dewatering Kit Bag #2 of 2
48SGSBEC1 	Emergency Communication Kit Bag
48SGSBEK1 	Electrical Kit Bag
48SGSBFFE	FFE Bag *Size can be printed on bag
48SGSBPP1 	Pipe Patching Kit Bag
48SGSBSC1 	Shoring Clamps Kit Bag
48SGSBSK1 	Sounding Kit Bag
48SGSBWK1 	Welding Kit Bag
48SGSCBA1	Damage Control SCBA Cover



48SGFDK1

* Individual Flags Also Available



48SGMSDK1



48SGDCK1

48SGSCBA1



48SGIET1



48SGSBFFK1



48SGSBST1



48SGSBSP1

* Specify When Ordering if Bag Printing is Desired *

“Right Away - Yours”

Contract Availability



FEDMALL



GSA ADVANTAGE

DAMAGE CONTROL

Repair Locker Kits **ONLY** available through Rayco Supply, Inc.

* Additional Repair Locker Kits May be Available upon Request *

Contents Subject to Change

*When ordering Please specify which station: DCRS-1, DCRS- 2, etc *



Kit, Electrical Repair- DC Safety, with Bag
Part Number: 48DCSEK



Kit, Investigator- DC Safety, with Bag
Part Number: 48DCSIK-Glove Size

* Pick ONE Glove Size: XS, S, M, L, XL, XXL *



Kit, Banding Tool
Part Number: 48DCSBTK



Kit, Monitoring Team, CBR
Part Number: 48DCSMTK



TO ORDER

Call: 1-757-431-0698

email: RAYCO@RAYCOSUPPLY.COM

Visit our website: RAYCOSUPPLY.COM

DAMAGE CONTROL

DCPO Tool Kit **ONLY** available through Rayco Supply, Inc.



Part Number: 48DCPOTC



Best Seller



Custom Designed



Quality Tools



One Low Price



DCPO Kit includes the following (updated regularly):

- | | | |
|---------------------------|-----------------------------|-----------------------|
| Inspection Mirror | Stencil Kit | Cotter Pin Assortment |
| Adjustable Spanner Wrench | Vise-Grips | Mechanical Finger |
| 6" Slipjoint Pliers | 11pc Combination Wrench Set | Work Gloves |
| 8" Slipjoint Pliers | 23 pc Socket Set | Rubber Gloves |
| Earmuffs | Flashlight | Safety Goggles |
| 10lb Bag of Rags | Tool Box | 24oz Ball Pein Hammer |
| 8pc Drive Pin Punch Set | 6" Adjustable Wrench | File Set |
| Machinist Rule | 8" Adjustable Wrench | 11pc Hex Key Set |
| Scraper | 10" Adjustable Wrench | 20pc Hex Key Set |
| 8pc Screwdriver Set | 12" Adjustable Wrench | 1 1/4" Putty Knife |
| Scriber | Paint Brush | Grease Gun |
| Oiler | Wire Brush | Chalk |

Available on



Schedule 84 GS-07F-074BA



SP47W1-17-D-0028

"Right Away - Yours"

Contract Availability



FEDMALL



GSA ADVANTAGE

DAMAGE CONTROL

Part Number	Description
453MN601PL	FM Pipe Markings *50/pkg
453MN602PL	AFFF Pipe Markings *50/pkg
453MN603PL	CW Pipe Markings *50/pkg
453MN604PL	JP-5 Pipe Markings *50/pkg
453MN605PL	Arrow Pipe Markings *50/pkg
453MN113PL	Exit Sign, 8" x 12" *10/pkg
453MN114PL	No Exit Sign, 9" x 10" *10/pkg
453MN115PL	Exit Arrow, 8" x 24", Left *10/pkg
453MN116PL	Exit Arrow, 8" x 24", Right *10/pkg
453MN117PL	Exit Arrow, 8" x 24", Double *10/pkg
453MN118PL	Exit Arrow, 4" x 12", Left *10/pkg
453MN119PL	Exit Arrow, 4" x 12", Right *10/pkg
453MN120PL	Exit Arrow, 4" x 12", Double *10/pkg
453MN121PL	D Arrow, 8" x 24", Left *10/pkg
453MN122PL	D Arrow, 4" x 12", Right *10/pkg
453MN123PL	+ (Medical) Arrow, 8" x 24" *10/pkg
453MN124PL	D Arrow, 8" x 24", Right *10/pkg
453MN125PL	D Arrow, 4" x 12", Left *10/pkg
453MN126PL	+ (Medical) Arrow, 4" x 12" *10/pkg
453MN127PL	+ (Medical) 8" x 8" *10/pkg
453MN130PL	FR Sign, 6" x 6" *10/pkg
453MN133PL	Flight Deck, 4" x 24" *10/pkg
453MN134PL	Flight Deck, 4" x 12" *10/pkg
453MN135PL	Hangar, 4" x 24" *10/pkg
453MN136PL	Hangar, 4" x 12" *10/pkg
453MN104PL	SCBA, 4" x 13", Vertical *10/pkg
453MN105PL	SCBA, 8" x 4", Horizontal *10/pkg
453MN106PL	Cylinders, 14" x 4", Horizontal *10/pkg

Manufacturer Minimum Order Requirements May Apply

EXIT

**NO
EXIT**

←EXIT→

Part Number	Description
453MNKITB	Bulls Eye Kit - Blue
453MNKITR	Bulls Eye Kit - Red
453MNCHAR2R_	Individual Characters - Red *10/pkg
453MNCHAR2B_	Individual Characters - Blue *10/pkg
453MN128PL	15" x 12" Backing for Bulls Eye *10/pkg

* For Individual Characters, Specify Character or Number when ordering *

FR

AFFF

FLT DECK

HANGAR

JP-5

SCBA

**Y
+
↓**

Description	2" x 2"	3" x 3"	4" x 4"
X-Ray *10/pkg	453MN003DG	453MN002DG	453MN001DG
Yoke *10/pkg	453MN006DG	453MN005DG	453MN004DG
Zebra *10/pkg	453MN009DG	453MN008DG	453MN007DG
William *10/pkg	453MN012DG	453MN011DG	453MN010DG
Circle X-Ray *10/pkg	453MN015DG	453MN014DG	453MN013DG
Circle Yoke *10/pkg	453MN018DG	453MN017DG	453MN016DG
Circle Zebra *10/pkg	453MN021DG	453MN020DG	453MN019DG
Circle William *10/pkg	453MN024DG	453MN023DG	453MN022DG
Darken Ship Zebra *10/pkg *MFR Min of 46	453MN027DG	453MN026DG	453MN025DG
Normally Open *10/pkg	453MN030DG	453MN029DG	453MN028DG
Normally Shut *10/pkg	453MN033DG	453MN032DG	453MN031DG



Part Number	Description
453MN107PL	EEBD, 1" x 3", Vertical *10/pkg
453MN108PL	EEBD, 2" x 6", Vertical *10/pkg
453MN109PL	EEBD, 3" x 1", Horizontal *10/pkg
453MN110PL	EEBD, 4" x 1-1/2", Horizontal *10/pkg
453MN111PL	EEBD, 8" x 4", Horizontal *10/pkg

Part Number	Description
453MN131PL	1" x 50 yds Photolum Tape
453MN132PL	2" x 50 yds Photolum Tape
453MN056DG	Escape Trunk Marker



DAMAGE CONTROL

DC Plates

Part Number	Description
48DCPZ44SS	DC Plate, 4 x 4, "Zebra", Stainless Steel
48DCPZ33SS	DC Plate, 3 x 3, "Zebra", Stainless Steel
48DCPY44SS	DC Plate, 4 x 4, "Yoke", Stainless Steel
48DCPY33SS	DC Plate, 3 x 3, "Yoke", Stainless Steel
48DCPXR44SS	DC Plate, 4 x 4, "X-Ray", Stainless Steel
48DCPXR33SS	DC Plate, 3 x 3, "X-Ray", Stainless Steel
48DCPW44SS	DC Plate, 4 x 4, "William", Stainless Steel
48DCPW33SS	DC Plate, 3 x 3, "William", Stainless Steel
48DCPDSZ44SS	DC Plate, 4 x 4, "Darken Ship", Stainless Steel
48DCPDSZ33SS	DC Plate, 3 x 3, "Darken Ship" Stainless Steel
48DCPCZ44SS	DC Plate, 4 x 4, "Circle Zebra", Stainless Steel
48DCPCZ33SS	DC Plate, 3 x 3, "Circle Zebra", Stainless Steel
48DCPCY44SS	DC Plate, 4 x 4, "Circle Yoke", Stainless Steel
48DCPCY33SS	DC Plate, 3 x 3, "Circle Yoke", Stainless Steel
48DCPCXR44SS	DC Plate, 4 x 4, "Circle X-Ray", Stainless Steel
48DCPCXR33SS	DC Plate, 3 x 3, "Circle X-Ray", Stainless Steel
48DCPCW44SS	DC Plate, 4 x 4, "Circle William", Stainless Steel
48DCPCW33SS	DC Plate, 3 x 3, "Circle William", Stainless Steel

Also Available in Aluminum

"Right Away - Yours"

Contract Availability



FEDMALL



GSA ADVANTAGE

ENGINEERING

Part Number	Description
76CED2 	Coverall, 9oz Deluxe Contractor

- One piece, topstitched, lay-flat collar
- Two-way concealed Nomex® taped brass break-away zipper
- Concealed snap at top of zipper at neck
- Concealed snap closure on sleeve cuff
- Elastic waist inserts
- Two front swing pockets are topstitched and lined
- Two chest pockets with flaps and concealed snaps
- Two patch hip pockets have single concealed snap closure
- Left Sleeve pocket
- Deep-pleated action back
- Side vent opening with snap closure
- Rule pocket on right leg



* When Ordering Specify:
Chest Measurement: 28"-72"
Length: Short, Reg, Long, X-Long
 Short: 5'3" - 5'7" • Regular: 5'7" - 5'11" • Long: 5'11" - 6'3" • X-Long: 6'3" - 6'5"

Excel FR® Flame-resistant, 9 oz. Twill,
 100% Cotton
 Arc Rating ATPV 10.6 calories/cm2

Part Number	Description
48NC9135852	Blue ENG Coverall, M - U.S. Navy (38 - 40)
48NC9135853	Blue ENG Coverall, L - U.S. Navy (42 - 44)
48NC9135854	Blue ENG Coverall, XL - U.S. Navy (46 - 48)
48NC9107165	Blue ENG Coverall, XXL - U.S. Navy (50 - 52)

Alpha Size	Neck	Sleeve	Chest
S	14-14.5	33.5	34-36
ST	14-14.5	35	34-36
M	15-15.5	34	38-40
MT	15-15.5	35.5	38-40
L	16-16.5	34.5	42-44
LT	16-16.5	36	42-44
XL	17-17.5	35	46-48
XLT	17-17.5	36.5	46-48
2XL	18-18.5	35.5	50-52
2XLT	18-18.5	37	50-52
3XL	19-19.5	36	54-56
3XLT	19-19.5	37.5	54-56
4XL	20-20.5	36.5	58-60
4XLT	20-20.5	38	58-60
5XL	21-21.5	37	62-64
5XLT	21-21.5	38.5	62-64

* Short, Regular, Tall, X - Long Lengths Available *



SP47W1-17-D-0028



48NC9135852



TO ORDER
 Call: 1-757-431-0698
 email: RAYCO@RAYCOSUPPLY.COM
 Visit our website: RAYCOSUPPLY.COM

ENGINEERING

Part Number	Description
76CJSNV1625MM	Arc Coverall, 12Cal/cm ² M - U.S. Navy (38 - 40)
76CJSNV1625LM	Arc Coverall, 12Cal/cm ² L - U.S. Navy (42 - 44)
76CJSNV1625XLM	Arc Coverall, 12Cal/cm ² XL - U.S. Navy (46 - 48)
76CJSNV16252XLM	Arc Coverall, 12Cal/cm ² 2XL - U.S. Navy (50 - 52)

Alpha Size	Neck	Sleeve	Chest
S	14-14.5	33.5	34-36
ST	14-14.5	35	34-36
M	15-15.5	34	38-40
MT	15-15.5	35.5	38-40
L	16-16.5	34.5	42-44
LT	16-16.5	36	42-44
XL	17-17.5	35	46-48
XLT	17-17.5	36.5	46-48
2XL	18-18.5	35.5	50-52
2XLT	18-18.5	37	50-52
3XL	19-19.5	36	54-56
3XLT	19-19.5	37.5	54-56
4XL	20-20.5	36.5	58-60
4XLT	20-20.5	38	58-60
5XL	21-21.5	37	62-64
5XLT	21-21.5	38.5	62-64

* Short, Regular, Tall, X - Long Lengths Also Available

* Additional Arc ratings Available *



Disposable Coveralls

Part Number	Description
251TY120SM	Coveralls, Tyvek, White, Disposable, Medium, 25/Case
251TY120SL	Coveralls, Tyvek, White, Disposable, Large, 25/Case
251TY120SXL	Coveralls, Tyvek, White, Disposable, X-Large, 25/Case
251TY120S2XL	Coveralls, Tyvek, White, Disposable, 2XL, 25/Case
251TY122SM	Coveralls, Tyvek, Disposable, Hood & Boots, Medium, 25/Case
251TY122SL	Coveralls, Tyvek, Disposable, Hood & Boots, Large, 25/Case
251TY122SXL	Coveralls, Tyvek, Disposable, Hood & Boots, X-Large, 25/Case
251TY122S2XL	Coveralls, Tyvek, Disposable, Hood & Boots, 2XL, 25/Case



“Right Away - Yours”

Contract Availability



FEDMALL



GSA ADVANTAGE

ENGINEERING



45COLEI580M



451212BLK00000

Product Number	Description
45COLEI580M	Anti-Exposure Work Suit w/Hood, Orange, Medium
45COLEI580L	Anti-Exposure Work Suit w/Hood, Orange, Large
451212BLK00000	1212 Low Profile Tactical Vest, Black
450978KIT00000	Rearming Kit for 1212 Vest
451422ORG03000	First Mate Vest, S/M
451422ORG05000	First Mate Vest, L/XL
453000002972	Powerboat Flotation Jacket Nylon Navy, Medium
453000002971	Powerboat Flotation Jacket Nylon Navy, Large
453000002970	Powerboat Flotation Jacket Nylon Navy, X-Large
45I375NAV00NAV	I375 Inflata-Belt™ Max Manual Inflatable Belt Pack

45I375NAV00NAV



Powerboat Flotation Jacket



First Mate Vest



ENGINEERING

Safety Items

* Several Varieties and Options Available *



Safety Glasses



Ear Plugs



Safety Goggles

Product	Description
76112318	 Gloves, ActivArm, Flame Resistant, Reinforced Palm & Knuckle, Impact Resistance, Utility, Kevlar & Neoprene, Small
76112320	 Gloves, ActivArm, Flame Resistant, Reinforced Palm & Knuckle, Impact Resistance, Utility, Kevlar & Neoprene, Large
76205675	Glove, Work Hyflex Light Duty Black Foam Nitrile Size 9
76205676	Glove, Work Hyflex Light Duty Black Foam Nitrile Size 10
RA2688330	Gloves, Cotton Canvas Clute Pattern Knit Wrist
76205752	Glove, Work, Green Nitrile Foam, Size 9
76205753	Glove, Work Nitrile Foam, Green, Size 10
RB1699070	Safety Goggles with Extra-Wide Lens Nonventilated, Clear Lens
UR3911004	Ear Plug, One Touch Refill, 500/cs, (For Use With Dispenser 2473910000)
47F400	High Performance Faceshield Headgears, 4 in Crown, 3C Ratchet
45LW210	Safety Glasses, Orange Temple Inserts, Clear Lens
15018350	ProFlex® 350 Gel Knee Pad



Knee Pads



ActivArm



76205676



76205752



Headgear & Faceshields



RB1699070



Don't see what you are looking for?

Contact your Rayco Rep for more information regarding the products in this category.

“Right Away - Yours”

Contract Availability



FEDMALL



GSA ADVANTAGE

ENGINEERING

LED Lighting

Available on



SP47W1-17-D-0028



24" 10W T12 4100K
PART: 74FLZT12G24

Designed for use in M16377 fluorescent fixtures. The LED tube works with or without the ballasts. This lamp is suitable for use in all M16337/8, /11, /12, /44*, /57, /72*, /73, /74, /75, /77, /80, /81 and /83 fixtures. Available in White, Red, and Blue.



48" 20W T12 4100K
PART: 74FLZT12G48

Designed for use in M16377/13 fixtures, and other 48" applications. For use in below deck, and exposed below deck applications. Only 20W of power, compared to the existing 56W fluorescent.



18" 8W T12 4100K
PART: 74FLZT12G18

Designed for use in M16377/5, /18 fixtures, and other 18" applications. This lamp is designed to operate with or without the ballast. Uses 50% less energy than fluorescent, only 8W compared to 15W.



24" 10W T8 4100K
PART: 74FLZT8G24

Designed for use in M16377 fluorescent fixtures. The LED tube works with or without the ballasts. This lamp is suitable for use in all M16337/77A, /78A, /79A, /80A, /81A, /82A, /83A, /84A, /85A fixtures. *Ford Class Carriers & LCS's only



12" 5W T5 4100K
PART: 74FLZT5G12

Designed for use in M16377/7B, /14B or other T5 lamp fixtures. This lamp is designed to operate with the ballast. Uses 35% less energy than fluorescent, only 5W compared to 8W.



TO ORDER

Call: 1-757-431-0698

email: RAYCO@RAYCOSUPPLY.COM

Visit our website: RAYCOSUPPLY.COM

ENGINEERING

Shipboard & Shore Lighting



65W WATERLINE SECURITY LIGHT
PART: 74EXPAL115654060



Explosion proof LED Waterline light fixture. Designed to mount to existing 2" diameter pole. Ultra high efficiency with up to 10,350 lumens, at 4100K. UL844 approved for shore use. IP66 rated. Replaces fixture M16377/61 with 60° beam angle.



LED BULBS
PART: 74LBA193115 (Specify Color)



Quickly replace the existing incandescent lamps in small globe fixtures, friendship lights or other applications. Available in standard 4100K White, NVIS Blue, NVIS Red, NVIS Yellow, NVIS Green A. 3W lamps replace a standard 50W light, for up to 90% energy savings.

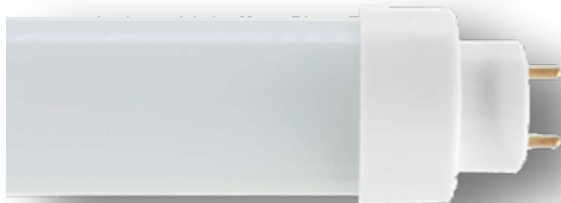

24" and 48" Non-Combat Ship Fluorescent Replacement
FLW Series



For non-combat ship fluorescent replacement. For use in any 24" or 48" retrofit application for shipboard use. UL1598 approved. Saves approximately 40% of electricity



48" 15W T8 or T12 Replacement
FLA Series



For shore building retrofits. For replacement of any T8 or T12 lamp, in accordance with UFC-3-350. Works with the existing, qualified, ballasts. TAA and/or BAA compliant product.

Available on



SP47W1-17-D-0028

"Right Away - Yours"

Contract Availability



FEDMALL



GSA ADVANTAGE



ENGINEERING



All Items Available on



SP47W1-17-D-0028

Part Number	Description
47907685	 Dynasty 210 Tig/Stick Welder
47907686	 Dynasty 210 DX Tig/Stick Welder
47951666	 Dynasty 210 Tig/Stick Welder w/ Foot Control Package
47951668	 Dynasty 210 DX Tig/Stick Welder w/ Foot Control Package

* Shipboard Plug not included with Welders *

Welders



47907685





47951666



47907757



47907134012

Part Number	Description
47907757	 Multimatic® 220 AC/DC 110 - 240 Volt Single Phase CC/CV Multi-Process Welder Contact Rayco Supply for full Specifications and Package Contents
47907134012	 Maxstar 161 S, Stick Package Includes: 13ft Electrode Holder 10ft Work Clamp Shoulder Strap Primary Cord & MVP Plugs Protective Miller X-case



47907199032



47907199032	 TIG Welder, Syncrowave 350 LX TIGRunner Series, 230/460/575VAC
-------------	--

* Shipboard Plug not included with Welders *

477171	 Shipboard Plug, 4 pin
--------	---





477171



ENGINEERING

Plasma Cutters & Torch Items

Part Number	Description
47907583	 Plasma Cutter, Spectrum 875, 20ft XT60
47907579	 Plasma Cutter, Spectrum 625 X-Treme, 12ft XT40 Quick Connect





Miller Spectrum Series



* Additional Torches and Kits Available *



Victor Cutmaster Series

47156302	 Cutmaster 60i, 208-480V, 3ph, 6.1 m (20 ft) SL60 QD (CSA)
47111302	 Plasma Cutter, Cutmaster 82, SL60 75 Deg. Head Hand Torch With 20ft Lead 460V 3 Phase

471200DM	 Studhorse 1200DM, With Digital Meter, 480V Three Phase, Stud Welding from 6mm-19mm Studs
47156302X	Cutmaster 60i, 3 ph with SL60QD 1Torch 20 ft (6.1m) 75 Head

Part Number	Description
4707810527	 Oxygen Welding Regulator
4707810584	 Acetylene Welding Regulator
4707813772	 Two Stage Argon/Helium Regulator

471200DM Studwelder



47156302X



4707813772

4707810527

4707810584

Part Number	Description
47780A1	 Oxy-Acetylene Torch Outfit, Uniweld Roughneck, CGA510, Heavy Duty Cutting & Welding Package Includes Torch Handle, Attachment, Oxygen And Acetylene Regulator, Cutting/ Heating/Welding Tips, Goggles, Flint Lighter And Hose
4703840840	 Portable Torch Outfit, Tote without Tanks
64003341	 Oxygen/Acetylene Hose 1/4" x 50'
65310200	 Hose Repair Kit



47780A1

4703840840





















“Right Away - Yours”

Contract Availability

 FEDMALL
 GSA ADVANTAGE

ENGINEERING

Air Cooled Tig Torches

	Torch Model	Torch Package	Capacity Amps*	Features	Electrode Sizes
	WT-9	WT-9-12R WT-9-12-2 WT-9-25R WT-9-25-2	125	Standard Model	.020" - 3/32"
	WT-9F	WT-9F-12R WT-9F-12-2 WT-9F-25R WT-9F-25-2	125	Flex Head Model	.020" - 3/32"
	WT-9FV	WT-9FV-12R WT-9FV-12-2 WT-9FV-25R WT-9FV-25-2	125	Flex Head with Valve	.020" - 3/32"
	WT-9P	WT-9P-12R WT-9P-12-2 WT-9P-25R WT-9P-25-2	125	Pencil Model	.020" - 3/32"
	WT-9V	WT-9V-12R WT-9V-12-2 WT-9V-25R WT-9V-25-2	125	Built-in Gas Valve	.020" - 3/32"
	WT-17	WT-17-12R WT-17-12-2 WT-17-25R WT-17-25-2	150	Standard Model	.020" - 1/8"
	WT-17F	WT-17F-12R WT-17F-12-2 WT-17F-25R WT-17F-25-2	150	Flex Head Model	.020" - 1/8"
	WT-17FV	WT-17FV-12R WT-17FV-12-2 WT-17FV-25R WT-17FV-25-2	150	Flex Head with Valve	.020" - 1/8"
	WT-17V	WT-17V-12R WT-17V-12-2 WT-17V-25R WT-17V-25-2	150	Built-in Gas Valve	.020" - 1/8"
	WT-23 A,B	Request Data Sheet A = 7" B = 14"	130	20 Style Machine Models	.020" - 1/8"
	WT-24	WT-24-12R WT-24-12-2 WT-24-25R WT-24-25-2	80	Small Head Model	.020" - 1/16"
	WT-24F	WT-24F-12R WT-24F-12-2 WT-24F-25R WT-24F-25-2	80	Flex Head Model	.020" - 1/16"
	WT-24FV	WT-24FV-12R WT-24FV-12-2 WT-24FV-25R WT-24FV-25-2	80	Flex Head with Valve	.020" - 1/16"
	WT-24V	WT-24V-12R WT-24V-12-2 WT-24V-25R WT-24V-25-2	80	Built-in Gas Valve	.020" - 1/16"
	WT-26	WT-26-12R WT-26-12-2 WT-26-25R WT-26-25-2	200	Standard Model	.020" - 1/8"
	WT-26F	WT-26F-12R WT-26F-12-2 WT-26F-25R WT-26F-25-2	200	Flex Head Model	.020" - 1/8"
	WT-26FV	WT-26FV-12R WT-26FV-12-2 WT-26FV-25R WT-26FV-25-2	200	Flex Head with Valve	.020" - 1/8"
	WT-26P	WT-26P-12R WT-26P-12-2 WT-26P-25R WT-26P-25-2	200	Pencil Model	.020" - 1/8"
	WT-26V	WT-26V-12R WT-26V-12-2 WT-26V-25R WT-26V-25-2	200	Built-in Gas Valve	.020" - 1/8"
	WT-27 A,B,C	Request Data Sheet	200	A = 9" B = 20" C = Robotic	.040" - 1/4"
	WT-29 A,B	Request Data Sheet A = 7" B = 14"	180	18 Style Machine Models	.020" - 5/32"

"V" indicates built-in gas valve. "F" indicates flexible head. "R" = flexible rubber cable & hose assembly.











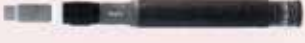

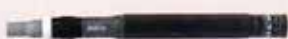

"FV" indicates flex head and built-in gas valve. -2 = 2 piece cable and hose assembly.

*AC or DCSP



ENGINEERING

Water Cooled Tig Torches

Torch Model	Torch Package	Capacity Amps*	Features	Electrode Size	
	WT-18	WT-18-12 WT-18-12R WT-18-25 WT-18-25R	350	Standard Model	.020" - 5/32"
	WT-18SP	WT-18SP-12 WT-18SP-12R WT-18SP-25 WT-18SP-25R	350	Pencil Model	.020" - 5/32"
	WT-18SPM	WT-18SPM-12 WT-18SPM-25	350	Machine Torch	.020" - 5/32"
	WT-18V	WT-18V-12 WT-18V-12R WT-18V-25 WT-18V-25R	350	Built-in Gas Valve	.020" - 5/32"
	WT-20	WT-20-12 WT-20-12R WT-20-25 WT-20-25R	250	Standard Model	.020" - 1/8"
	WT-20F	WT-20F-12 WT-20F-12R WT-20F-25 WT-20F-25R	225	Flex Head Model	.020" - 1/8"
	WT-20H	WT-20H-12 WT-20H-12R WT-20H-25 WT-20H-25R	300	Heavy Duty Model	.020" - 5/32"
	WT-20P	WT-20P-12 WT-20P-12R WT-20P-25 WT-20P-25R	225	Pencil Model	.020" - 1/8"
	WT-20V	WT-20V-12 WT-20V-12R WT-20V-25 WT-20V-25R	250	Built-in Gas Valve	.020" - 1/8"
	WT-22 A,B	Request Data Sheet A = 7" B = 14"	260	20 Style Machine Models	.020" - 1/8"
	WT-24W	WT-24W-12 WT-24W-12R WT-24W-25 WT-24W-25R	180	Small Head Model	.020" - 3/32"
	WT-24WF	WT-24WF-12 WT-24WF-12R WT-24WF-25 WT-24WF-25R	180	Flex Head Model	.020" - 3/32"
	WT-25	WT-25-12 WT-25-12R WT-25-25 WT-25-25R	225	Flex Neck Pencil	.020" - 1/8"
	WT-27AW	Request Data Sheet	500	9" Machine Model	.040" - 1/4"
	WT-27BW	Request Data Sheet	500	20" Machine Model	.040" - 1/4"
	WT-27CW	Request Data Sheet	500	9" Robotic Model	.040" - 1/4"
	WT-28 A,B	Request Data Sheet A = 7" B = 14"	350	18 Style Machine Models	.020" - 5/32"

"V" indicates built-in gas valve. "F" indicates flexible head. "R" = flexible rubber cable & hose assembly.

*AC or DCSP

"Right Away - Yours"

Contract Availability



FEDMALL



GSA ADVANTAGE

ENGINEERING

Part Number	Description
47TEP11610T (GRN)	Tungsten Electrode, 1/16in x 7in, Pure
47TEP33210T (GRN)	Tungsten Electrode, 3/32in x 7in, Pure
47TEP1810T (GRN)	Tungsten Electrode, 1/8in x 7in, Pure
47TE2C11610T (RED)	Tungsten Electrode, 1/16in x 7in, 2% Thoriated
47TE2C33210T (RED)	Tungsten Electrode, 3/32in x 7in, 2% Thoriated
47TECC1810T (RED)	Tungsten Electrode, 1/8in x 7in, 2% Thoriated
9003327GL (GLD)	Tungsten Electrode, 3/32" x 7"L, 1.5% Lanthanated
900187GL (GLD)	Tungsten Electrode, 1/8" x 7"L, 1.5% Lanthanated
9001167GL (GLD)	Tungsten Electrode, 1/16" x 7"L, 1.5% Lanthanated
474043116TW	Tig Rod, Aluminum 4043, 1/16in x 36in
47404318	Tig Rod, Aluminum 4043, 1/8in x 36in
474043332TW	Tig Rod, Aluminum 4043, 3/32in x 36in
475356116TW	Tig Rod, Aluminum ER5356, 1/16in x 36in
47535618TW	Tig Rod, Aluminum ER5356, 1/8in x 36in
475356332TW	Tig Rod, Aluminum ER5356, 3/32in x 36in
64001646	Tig Rod, Carbon Steel ER70S-2, 1/16in x 36in
64001648	Tig Rod, Carbon Steel ER70S-2, 1/8in x 36in
64001647	Tig Rod, Carbon Steel ER70S-2, 3/32in x 36in
47SST308L11636	Tig Rod, Stainless Steel 308L, 1/16in x 36in
47308L1836	Tig Rod, Stainless Steel 308L, 1/8in x 36in
64001582	Tig Rod, Stainless Steel 316L, 1/16in x 36in
64001584	Tig Rod, Stainless Steel 308L, 3/32in x 36in
47RN6018TW	Tig Rod, NiCu RN60, 1/8in x 36in
47RN60332TW	Tig Rod, NiCu RN60, 3/32in x 36in
47MLY8211636F1T	Tig Rod, Inconel RN82, 1/16in x 36in
64001102	Electrode, Carbon Steel, 7018, 3/32in
4715620F1	Rod, Brazing Grade 3, 1/8in x 20in
4715320F1	Rod, Brazing Grade 3, 1/16in x 20in
47HAR5031	Brazing Wire, Grade 4, 1/16in
47BRZ50N31CD	Brazing Wire, Grade 5, 1/16in, w/Cd 50% + Ni
47SSWF1	Brazing Flux, 1 Lb Jar
64001514	Mig Wire, ER5356 Aluminum .035in Diameter, 1 Lb Spool
64001212	Mig Wire, ER70S-6 Carbon Steel, .035in Diameter, 2 Lb Spool

Consumables

Part Number	Description
23174510	White Metal Marker
471111	Belzona Super Metal Compound

471111



Part Number	Description
4703230191	FE Flexible Weld Nozzle w/o Tip End
4703820034	315FC Torch Handle
4703300115	Scarfing Tip #6 for 315FC
4703300116	Scarfing Tip #8 for 315FC

23174510



4703820034



Part Number	Description
4703110471	000-TE Brazing Tip
4703110472	00-TE Brazing Tip
4703110473	0-TE Brazing Tip
4703110474	1-TE Brazing Tip
4703110475	2-TE Brazing Tip
4703110587	3-TE Brazing Tip
4703110588	4-TE Brazing Tip
4703110589	5-TE Brazing Tip

4703230191



4703300115



4703110471



470330004

47SSWF1



72XZC010



Part Number	Description
4703300004	00-1-101 Welding Cutting Tip
4703300003	000-1-101 Welding Cutting Tip
4703300012	0-1-101 Welding Cutting Tip
4703300005	1-1-101 Welding Cutting Tip
4703300006	2-1-101 Welding Cutting Tip
4703300002	3-1-101 Welding Cutting Tip
4703300007	4-1-101 Welding Cutting Tip
4703300008	5-1-101 Welding Cutting Tip
4703300009	6-1-101 Welding Cutting Tip

* Contact us with any type not listed



TO ORDER



Call: 1-757-431-0698

email: RAYCO@RAYCOSUPPLY.COM

Visit our website: RAYCOSUPPLY.COM

ENGINEERING

Accessories

Part Number	Description
471165	 Welding Helmet, Pipe Hood
4764005100	Welding Helmet, Auto-Darkening, Shade 10
4707440504	 Helmet, Welding, Shadow HSL-100, Passive
47256159	 Helmet, Welding, Digital Performance Series, Black
4764005105	Welding Lens, Auto-Darkening, Shade 10 (Fixed), 2" x 4-1/4" for Lift Front Welding Helmets



471165



4764005100



47256159



4707440504

Part Number	Description
47R100L	Gloves, Welders, Large, 14in
47TIL25BM	Gloves, Tig/Mig, Medium
47TIL25BL	Gloves, Tig/Mig, Large
47RAD64055063	Welding Jacket, Leather Large



47R100L



Tig/Mig Gloves



Welding Jacket



Weld Curtain

Part Number	Description
RA1487364	Weld Cloth, AMI-Glass, Heat Cleaned * Price Per 50yd Roll MIL-C-20079H
45AS36000710GR	Welding Curtain, 10' x 7', Grommets on Top 7' Part, MIL-C-24576, Type 1 Class 1, Black
45AS36001006	Welding Curtain, 6' x 10', Grommets on Top 6' Part, MIL-C-24576, Type 1 Class 1, Black
65610302	Rod Guard, 18"
4730012	Rod Guard, 36"
20640402	Burr Kit, 1/4in Shank, Double Cut, 8 pc

Part Number	Description
6472035	 Piping Size Calipers
64002008	Cone and Chisel Handle
64003400	Combo 10 Way Welding Wrench
378A	Dual Tool, Chipping Hammer, Steel Head, Coil Handle, Wire Brush, Welded Brush Box



6472035



378A



64002008



64003400



4770059



472MPC



47A532



47GC300

Part Number	Description
4770059	Welding Pipe Stinger 150 Amp
47A532	 Welding Electrode Holder 200 Amp
472MPC	#2 Weld Cable Connector
47GC300	Welding Junior Ground Clamp

Contract Availability

“Right Away - Yours”



FEDMALL

GSA ADVANTAGE

ENGINEERING

Drain Cleaning

Part Number	Description
44SVCWC	Super-Vee Drain Cleaner
44MRPA	Mini Rooter Pro Package, Includes: 4450EM2 & 44MRCS
44MRCS	Cutter Set for Drain Cleaners
44KRDWC	Kinetic Water Ram
44KRRK	Ram Repair Kit
44TU4	Auger, Urinal
4450EM2	Replacement Cable 3/8" X 50 Ft



5-Piece Cutter Set
For Use Only With Cables
Having Connectors

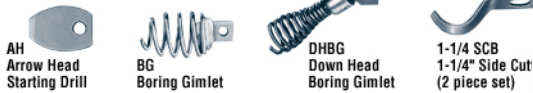

44MRCS

44TU4

44SVCWC

4450EM2

44MRPA

Part Number	Description
44SDP500	Gen-Eye SD Command Module



44KRDWC

44SD500



44CGPB

Part Number	Description
44CGPB	Mini-Pod - Compact Stand and Reel w/125ft Gel Rod, 2in to 4in Line Capacity, Sonde (Digital Locator), Mini Color Camera, 7in LCD Monitor, w/Padded Bag.
44CGPD	Mini-Pod - Compact Stand and Reel w/175ft Gel Rod, 2in to 4in Line Capacity, Sonde (Digital Locator), Mini Color Camera, 7in LCD Monitor, w/Padded Bag
44SLGPF	POD with Self-Leveling Color Camera, 200 Ft. Gel-Rod, Digital Locator with Padded Bag



44SLGPF



ENGINEERING

Head Replacement Items



443057005

Part Number	Description
443057005	Flushometer Dolphin Exposed Water Closet
443057053	Flushometer Dolphin Exposed Urinal
440337136	Dolphin Flushometer Repair Kit
441861ESS	Exposed Flushometer, Urinal, Sensor Operated, 1 Gallon per Flush, Chrome Plated Finish, Inlet 3/4", Spud Coupling 3/4" - Military Spec V-29193



441861ESS







444540



447385

Part Number	Description
447385	 Single Lever Faucet

Part Number	Description
444540	Scuttlebutt - Drinking Fountain

Part Number	Description
44511150JTC	Chrome Plated Marine P-Trap, 1-1/2"
4440501	 Closet Spud, 1-1/2"
4440141701	 Drain Stopper, Rubber, with Chain, 1 to 1 3/8" Diameter
4409922499	 Seat, 1955C Plastic EB of LC Black
44S3357	 Lavatory Drain, Chrome Plated, Brass Pop-Up



4440141701



4409922499



4440501



44S3357



44SC1220AF

Part Number	Description
44SC1220AF	 Shower, Exposed, with 44S2292 Head
44RPG040323	4-Arm Handle for 44SC1220AF
44RPG030371	Spindle Assembly for 44SC1220AF
44S2292	Showerhead, Flow Control 2.5gpm, Spray Adjust T-Handle
44SC1210AF	Shower, Exposed, Includes Risers, with 44S2292 Head



44SC1210AF

“Right Away - Yours”

Contract Availability



FEDMALL



GSA ADVANTAGE

ENGINEERING

Flowmeters

FLUXUS F401

Heavy duty portable ultrasonic water flow meter
Long-term operation, robust design, accurate measurements

43F401SM - Small Pipe (1"-8")



- Black case sold separately -

- Product variant: FLUXUS® F401
Pipe diameter range: 1" - 8"
Pipe material: All
Media: Water / Wastewater
Battery lifetime: Several months (depending on measurement interval)
Solid or gas content: up to 6 % in volume
Flow velocity: 0.01 ... 25 m/s
Accuracy: $\pm 2\%$ of reading ± 0.01 m/s
Repeatability: 0.25 % of reading ± 0.01 m/s
Transducer cable length: 19 ft
Transducer protection degree: IP68
Transducer coupling material:
 Pads (for long-term installations)
 and gel (for short-term installations)
Transmitter protection degree:
 IP67 (housing closed)
Number of flow measuring channels: 1
Communication options: RS232
Data logger: > 100,000 values
Outputs: 1x Current, 1x Binary



ENGINEERING



FLUXUS F601

Industrial Portable Flowmeter
43F601



Measurement uncertainty
(volumetric flow rate): $\pm 1\%$ of reading ± 0.02 ft/s

Repeatability: 0.15% of reading ± 0.02 ft/s

Flow velocity range: 0.03 to 82 ft/s

Ex zone transmitter: only safe area

Power supply: Li-ION 7.2V/6.2Ah Operat. time >25h

Available transducer: Shear wave
for Ex zones: ---

for pipe sizes range: 0.24 inch to 255.9 inch

for temperature range: -40°F to $+392^{\circ}\text{F}$ /
WI: -328°F to $+1112^{\circ}\text{F}$

Outputs: 4-20mA active/passive
pulse/frequency/binary

Inputs: Pt100/Pt1000
4-20mA passive

Digital communication: Modbus RTU



“Right Away - Yours”

Contract Availability



FEDMALL



GSA ADVANTAGE

ENGINEERING

Information Required (X) to Quote Metals

Type	NPS	OD	ID	Wall	Schedule	Alloy	Length	Width	Thickness	Diameter
Angle						X	X	X	X (each leg)	
Expanded Metal						X	X	X	X	X Dia. of hole punched & spac- ing of holes
Flat Bar						X	X	X	X	
Hex Bar						X	X	X (Across the flats)		
Perforated Metal						X	X	X	X	X Dia. of hole punched & spac- ing of holes
Pipe	X				X	X	X			
Plate						X	X	X	X	
Round Bar						X	X			X
Sheet						X	X	X	X	
Square Bar						X	X	X	X	
Tubing		X	X	X		X	X			

Please note if you have a specification associated with your request; i.e. ASTM-A-36

Examples of Alloys

Aluminum	Copper Nickel	Brass	Nickel	Carbon Steel	Stainless Steel
6061	70/30	360 Naval	400	A-36	304
6063	90/10	464 Naval	405	A-53	304L
5052			600	1018	316
5086				1006	316L
5456					303

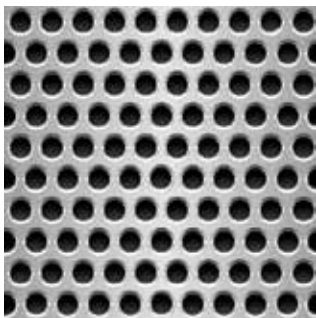

ENGINEERING

SCREWS, BOLTS, NUTS, & WASHERS

* When ordering hardware, please include the following:

- Type
- Thread: full or partial
- Threads Per Inch
- Overall Length
- Material/Coating
- Head & Drive Style

Drive Style

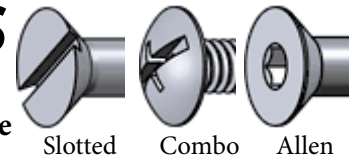

Slotted Combo Allen

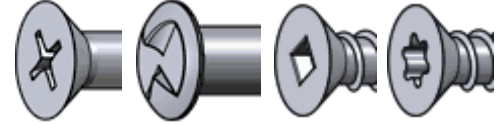

Phillips One-Way Square Torx

Screws & Bolts

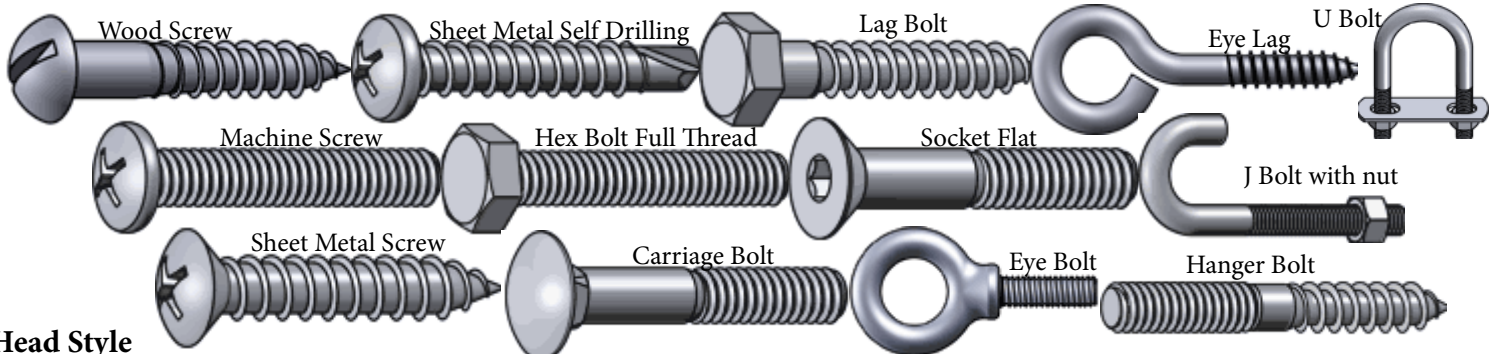

Head Style

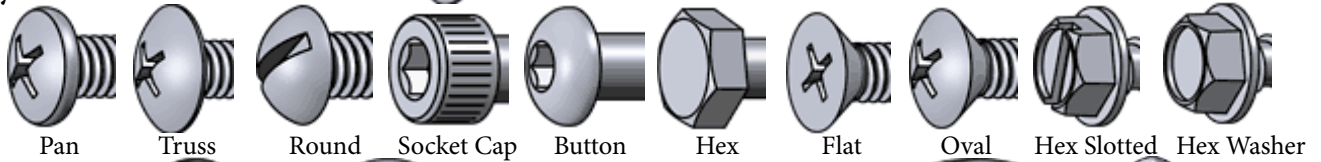

Nut Type

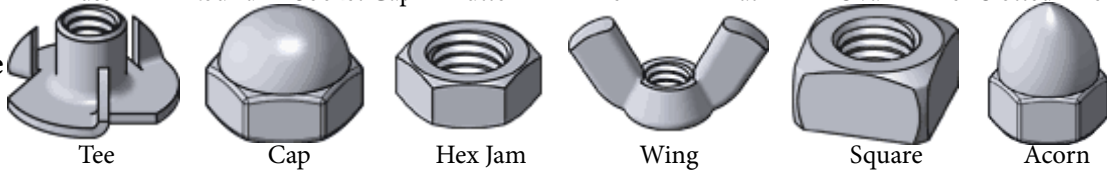

Washer Type

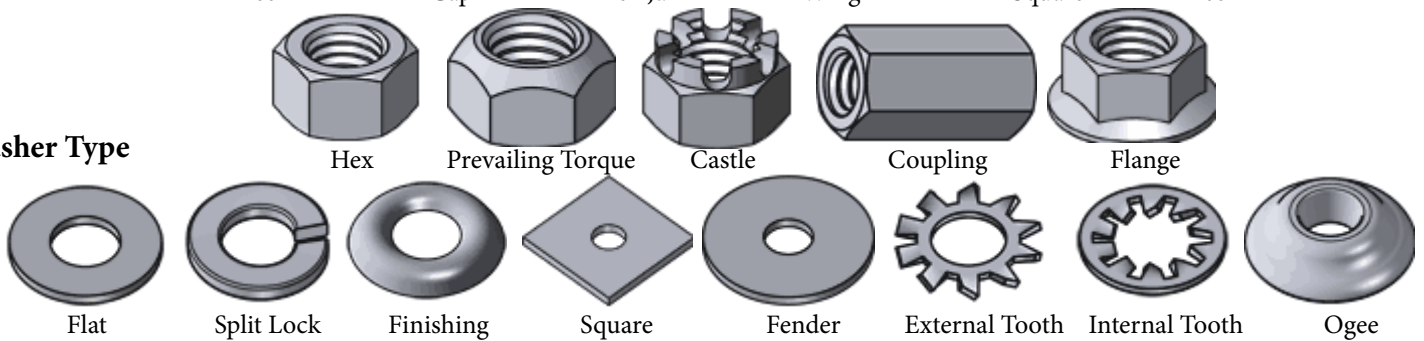

Materials & Coatings:

Stainless Steel, Steel, Silicon Bronze, Brass, Aluminum, Zinc Plating, Galvanized, Chrome



Don't see what you are looking for?

Contact your Rayco Rep for more information regarding the products in this category.

"Right Away - Yours"

Contract Availability



FEDMALL

GSA ADVANTAGE

ENGINEERING

Fittings



Reducing Bushing



Pipe Cap



Pipe Plug



45 Deg Elbow



Single Sweep Tee

When requesting a quote for items in this category please provide:

Item Type, Size, Material, Connection Type & Pressure rating/ Pipe Schedule or Class



Tee



90 Deg Elbow



Union

Item Type	Size	Material	Connection Type	Pressure Rating or Pipe Schedule/Class
Adapter	1/4" NPS	Aluminum 5052	Backing Ring	125#
Backing Ring	3/8" NPS	Aluminum 5086	Bell End	150#
Cap	1/2" NPS	Aluminum 6061	Blind	200#
Coupling	3/4" NPS	Bronze	Butt Weld	250#
Cross	1" NPS	Carbon Steel A105	Sil-Braze	300#
Elbow 45	1-1/4" NPS	Carbon Steel A532	Slip-On	3000#
Elbow 90	1-1/2" NPS	Carbon Steel LF2	Solder	400#
Elbow LR	2" NPS	Chromemoly F-11	Socket Weld	500#
Elbow SR	3" NPS	Copper Nickel 70/30	Threaded	6000#
Flange	4" NPS	Copper Nickel 90/10	Weld Neck	700#
Reducing Elbow	5" NPS	Galvanized		900#
Reducing Tee	6" NPS	Iconel 600		9000#
Sleeve	8" NPS	Monel 400		SCH 10
Tee	10" NPS	PVC		SCH 40
Union	12" NPS	Stainless Steel 304		SCH 80
Y Lateral	14" NPS	Stainless Steel 304L		Class 200
	16" NPS	Stainless Steel 316		
	18" NPS	Stainless Steel 316L		

Many of these Items Available on



SP47W1-17-D-0028

Lokring and Swage Fittings and Valves Available!!



Flange



Coupling



Cross



Long Turn 90 Deg Elbow



Y-Lateral



TO ORDER

Call: 1-757-431-0698

email: RAYCO@RAYCOSUPPLY.COM

Visit our website: RAYCOSUPPLY.COM

ENGINEERING



CUNI: 1/4", 3/8", 1/2", 3/4", 1", 1-1/4", 1-1/2", 2" supplied in Class 200 or Class 700 options

When requesting a quote, please include the following information:
CUNI, SS or Carbon Steel, diameter (ex: 1/4", 1/2", 1", etc.)
Type of pipe fitting desired (ex: 90 elbow, tee, union, etc.)



Stainless Steel: 1/4", 3/8", 1/2", 3/4", 1", 1-1/4", 1-1/2", 2"

LOKRING Tooling Kits

51MTK2002FR - Lokring Tools Kit for
CN200 Copper Nickel Pipe Fittings, 1/4" - 2"

51MTK33001FR - Lokring Tools Kit for
Stainless Steel Pipe Fittings, 1/4" - 1"

*Individual Tooling Kits are Available for Stainless Steel Sizes,
1-1/4", 1-1/2", and 2" Upon Request*



"Right Away - Yours"

Contract Availability



FEDMALL

GSA ADVANTAGE

ENGINEERING

Navy & Mil-Spec Valves

- MIL-T-960 Steam Trap: Bronze & Steel, Silbraze, Socketweld & Flanged
- MIL-V-1189 Navy Gate Valve Type I, Class 1,2,3 Bronze Flanged 100, 250 & 400 LB
- MIL-V-2042 Liquid Pressure Regulator, Bronze, UESB & Flanged
- MIL-T-2118 Steam Trap / Strainer Combination Type, Bronze, UESB
- MIL-S-2953 Strainer, Y-Type & Simplex, Bronze & Steel
- MIL-V-2961 Air Pressure Reducer, Bronze, UESB
- MIL-V-3155 Temperature Regulator, Bronze, UESB
- MIL-V-15020 Flush Valves, Type I & II
- MIL-S-16293 Strainers, Bronze, Steel & Iron
- MIL-V-17501 Magazine Sprinkler Valve, Bronze, UESB & Flanged
- MIL-V-17547 Navy Check Valve, Type A & B, Class 1 & 2, Bronze Flanged 100 & 250 LB
- MIL-V-17737 Boiler Blowoff Valve, Steel, CRMO F-22 & Monel, Flanged 600 and 1500 LB
- MIL-V-17848 Steam Reducer, Steel Flanged
- MIL-S-17849 Duplex Strainers, Bronze Flanged, Type II, Class 2
- MIL-V-18110 Gate Valve Steel & CRMO F-11, S/W, B/W & Flanged 150 to 1500 LB
- MIL-V-18436 Check Valve, Steel, Bronze & Iron, Flanged and Socketweld
- MIL-V-19772 Temperature Regulator, Bronze, UESB & Flanged
- MIL-V-20065 Steam Relief Valve, Bronze & Steel, UESB & Flanged
- MIL-V-22052 Globe & Angle Valve, Steel & F-11, B/W & Flanged 150 to 1500 LB
- MIL-V-22094 Globe & Angle Valve, Steel & F-11, S/W & Flanged 600 and 1500 LB
- MIL-V-22133 Butterfly Valve, Bronze Body, Monel Trim, Resilient Seated
- MIL-V-22549 Air Relief Valve, Bronze, UESB & Flanged
- MIL-V-24109 Globe, Angle & Check Valve, O-Seal Type, Bronze, UESB 6000 LB
- MIL-V-24332 Liquid Relief Valve, Bronze, UESB & Flanged
- MIL-V-24384 Air Pressure Reducer, Bronze, UESB
- MIL-V-24509 Ball Valve, Bronze Flanged, 2 way & 3 way
- MIL-V-24509 Plug Valve, Bronze Flanged, 2 way & 3 way
- MIL-V-24578 Gate Valve, Stainless & Monel, 6000 LB
- MIL-V-24586 Barstock Needle Valve, Steel & Stainless, Threaded & S/W
- MIL-V-24624 High Performance Butterfly Valves, Bronze & Stainless
- DWG-1385541 Navy B-135 Globe & Angle Valve, Bronze & Monel, Flanged 100 LB
- DWG-1385623 Navy Y-Pattern Globe Valve, Bronze Flanged 250 LB
- DWG-1385637 Navy Swing Check Valve Type A, Class 2, Bronze Flanged 250 LB
- DWG-1385673 Navy B-136 Globe & Angle Valve, Bronze Flanged 200 LB
- DWG-1385707 Navy Horizontal Scupper
- DWG-1385711 Navy Hose Globe & Angle Valve, Union Bonnet, Bronze Flanged 250 LB, 1 1/2"
- DWG-1385712 Navy Hose Globe & Angle Valve, Bolted Bonnet, Bronze Flanged 250 LB, 2 1/2"
- DWG-1385714 Gate Valve, Bronze UESB, including Indicator Type & Lockshield
- DWG-1385721 Swing Check Valve, Bronze UESB
- DWG-1385789 Deck Drain, CuNi, Bronze & Aluminum, Type A, B, C, D, E, G, H
- DWG-1385901 Marine Main Strainer & Valve, Bronze Silbraze
- DWG-2177525 Globe, Angle, Check Valve, Steel, SS, Monel, S/W & Flanged 600 to 900 LB
- DWG-2177917 Navy Gate Valve, Type I, Class 2, Bronze Flanged 250 LB
- DWG-4384536 Globe & Angle Valve, Bronze UESB, Class A & B, Type 1 thru 5
- DWG-5001003 Bronze Ball Valves, 3-piece Style, 1/4" to 2 1/2"
- DWG-5001004 Bronze Ball Valves, 3-piece Style, 3" to 6"
- DWG-5001057 Drain Strainer Orifice Assembly, Steel, S/W 900 LB
- DWG-5184193 Globe & Angle Valve F-11, S/W, 1500 LB
- DWG-Various Scuppers and Discharge Fittings, Bronze Flanged
- DOD-V-24657 Electric Valve Actuation- Digital Network or Hard Wired



SWING CHECK
411501
MIL-V-17547 TYPE A CLASS 1
Sizes: 1 " to 12"



GATE VALVE
411101
MIL-V-1189
Sizes: 1" to 8"



GLOBE VALVE
414301
DWG 4384536
Sizes: 1/4 " to 2"



GATE VALVE
414101
DWG 1385714
Sizes: 1/4 " to 2"



SWING CHECK VALVE
414501
DWG 1385721, 5384536
Sizes: 1/4 " to 2"

Many of these Items
Available on



SP47W1-17-D-0028



TO ORDER

Call: 1-757-431-0698

email: RAYCO@RAYCOSUPPLY.COM

Visit our website: RAYCOSUPPLY.COM

ENGINEERING

Navy & Mil-Spec Pipe & Fittings

- MIL-F-1183 Bronze Silbraze Fittings
- MIL-F-24202 70/30 Class 700 Butt weld Fittings
- MIL-F-24227 Bronze UT Silbraze Fittings 400 LB
- DWG-841337 Bronze 3000 LB UT Silbraze Fittings
- DWG-841338 Bronze 3000 LB Silbraze Fittings
- DWG-841499 Bronze Silbraze Y-Strainer 250 LB
- DWG-841626 Bronze 3000 LB Silbraze Gage-Line Fittings
- DWG-1385866 Steel Bulkhead Sleeve & Deck Sleeve
- DWG-1385880 90/10 & 70/30 Copper Nickel Butt weld Fittings CL 200
- DWG-5959353 90/10 & 70/30 Copper Nickel Butt weld Belled Fittings CL 200
- DWG-6397430 90/10 & 70/30 Copper Nickel Socket weld Fittings 400 LB
- DWG-1385883 Bronze 3000 LB Silbraze Unions O-Ring Gasket
- DWG-1385886 Bronze 3000 LB Silbraze Fittings OD
- DWG-1385912 Boss, Solid Type, 70/30 & 90/10, Bronze & Steel
- DWG-1385941 Bronze UT 3000 LB Silbraze Gage-Line Fittings
- DWG-1385942 Bronze UT 1500 LB Silbraze Fittings
- DWG-1385943 Bronze UT 3000 LB Silbraze Unions
- DWG-1385944 Bronze UT 3000 LB Silbraze Fittings
- DWG-1385946 Bronze UT 1500 LB Silbraze Unions
- DWG-1385950 Bosses, All Materials
- DWG-2145801 Steel Bulkhead Sleeve & Deck Sleeve
- DWG-2424406 Steel Bulkhead Sleeve & Deck Sleeve
- DWG-2424424 Steel Insulated Deck Sleeve
- DWG-3160733 Copper Funnel, Round & Oval
- DWG-4715320 Copper Funnel, Round & Oval
- DWG-Various Bronze, 90/10 & 70/30 Brazolets & Outlet Fittings
- ASTM B61/62 Bronze Screwed Fittings, Std & XH
- ASTM A-105 Forged Steel Fittings, Threaded & Socket weld, 3000 LB and 6000 LB
- ASTM A-182 F-11 & F-22 CRMO Fittings, Socket weld, 3000 LB and 6000 LB
- ASTM A-182 SS Fittings, Type 304 & 316 Threaded & Socket weld, 3000 LB and 6000 LB
- ASTM A-234 Carbon Steel Fittings, Butt weld, All Schedules



Flanges

- | | |
|-------------|--|
| MIL-F-20042 | Bronze Silbraze Flanges |
| MIL-F-20670 | Steel B-110 Slip-on & Weldneck Flanges Type A, B, C & D |
| DWG-1385892 | Butterfly Flange 200 LB Bronze Silbraze |
| DWG-1385992 | 90/10 & 70/30 Copper Nickel Flanges Weldneck 250 LB |
| DWG-4715319 | 90/10 & 70/30 Copper Nickel Flanges S/W & Slip-on |
| ASTM A-105 | Steel Slip-on, Socket weld & Weldneck Flanges 150 to 1500 LB |
| ASTM A-182 | F-11 CRMO Socket weld Flanges 600 to 1500 LB |

Many of these Items Available on



SP47W1-17-D-0028

Pipe & Tubing

- MIL-P-1144 Stainless Steel Pipe & Tubing
- MIL-T-1368 Monel Pipe
- MIL-T-15005 90/10 & 70/30 CuNi Condenser Tubing
- MIL-T-16420 90/10 & 70/30 CuNi Pipe, 1/4" OD through 8" Seamless
- MIL-T-18165 P-11 CRMO Pipe, Schedule 40 & 80
- MIL-T-20157 Steel Pipe, Schedule 40 & 80
- MIL-T-24107 Deoxidized Copper Pipe, 1/4" OD Through 8" Seamless
- MIL-P-24691 Steel, CRMO & Stainless Pipe
- ASTM A-106 Steel Pipe, Black & Galvanized, Std & XH Seamless
- ASTM B-42 Copper Pipe, Schedule 40 & 80, Seamless
- ASTM B-43 Brass Pipe, Schedule 40 & 80, Seamless
- ASTM B-88 Copper Water Tube, Type K, L, M
- ASTM A-53 Steel Pipe, Black & Galvanized, Std & XH Welded



Metals

- | | |
|--------------|---------------------------|
| MIL-C-15726 | Copper Nickel Plate & Rod |
| MIL-B-16541 | Bronze Castings |
| MIL-S-18410 | CRMO Forgings F-11 & F-22 |
| QQ-N-281/288 | Monel Forgings / Castings |
| 5086/6061 | Aluminum Forgings |



Contact your Rayco Rep for more information regarding the products in these categories.

“Right Away - Yours”

Contract Availability



ENGINEERING

Machinery



Part Number	Description
426375	Hydraulic Shear, 6' x 3/8" This shear has the capacity to cut 1/4" diamond plated stainless steel.

Hydraulic Shear, 6' x 3/8" Betenbender, 36" Power Backgauge with LED Readout, 4' Squaring Arm with Inlaid Scale, Power Adjust Variable Rake, Hydraulic Self-Compensating Holddown Bar Assy, Bolt Together Assembly



Pull-X Machines



Part Number	Description
4212308190	 P201 42" Throat Depth 460V 3 Phase Universal Sheet Metal Machine Base Unit

Includes the Following

- Fully capsuled knee-joint mechanism working in oil bath
- Reinforced links system for better rotary stiffness
- 7 different stroke lengths between 1,7 and 7mm
- Variator adjusted stroke frequency between 400 and 4000 strokes/min
- Lower tool holder block, complete, gives quick and easy tool change
- Electric equipment of contactor type and transformer for 100v supply voltage
- Electric motor 1.5 kW, for 220 or 380 V, 50 c/s, 3-phase AC
- Manual mounting of the tool
- Machine bases
- Circle cutting tools
- Grinding gauge
- Spanners
- Instruction and spare part manual
- Standard color blue RAL 5015 and RAL 5024

Talk to your Rayco rep about different options for this item; Beading, Jogging, Punching, Nibbling, Doming, Louvering, Flanging, Edge Bending, Cutting, Slot Cutting, & Special Accessories such as an outer centre attachment, swivelling, circular cutting, & straight cutting.



ENGINEERING



Machinery

Tube And Pipe Notcher TN-800

The TN-800 Tube and Pipe Notcher does what no other tubing notcher on the market can do: notch tube from 1" to 3" OD without any change in tooling, hole saws, or mandrels.



Part Number	Description
42TN800	Tube and Pipe Notcher

Top Benders

Part Number	Description
42050KD	Top Bender Machine, 050KD, Rotary Draw Tube & Pipe
42TB130	Top Bender Machine, TB130, Touch Screen, Digital Display



Metal Cutting Band Saw



Part Number	Description
42BS712M	Bandsaw, Horizontal/Vertical, 7" x 10-1/4", 110V, 1HP, 1PH

Hydraulic Ironworker

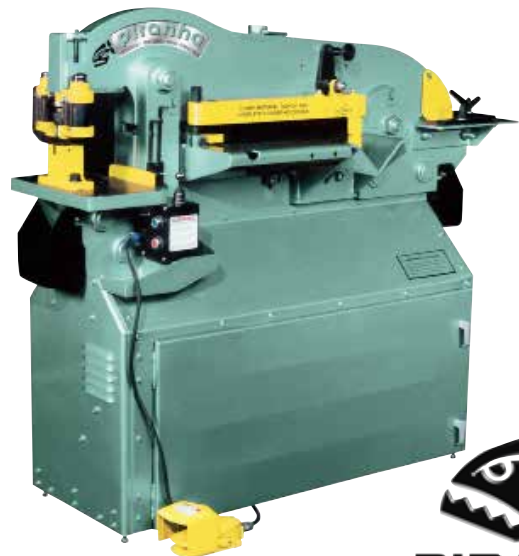

Part Number	Description
46P65	Hydraulic Ironworker P65 Model

"Right Away - Yours"

Contract Availability



FEDMALL



GSA ADVANTAGE

ENGINEERING



68164517



68165122



40953000

Machine Tools



10640301

Part Number	Description
40953000	Drill Bit Set, 29 pc, HSS, Jobber Length, 1/16" - 1/2", 1/64" Increments
10640301	Drill Bit Set, 115 pc, Cobalt, Jobber Length
68164517	Dial Calipers, 0-9"
68165122	Dial Caliper & Micrometer Set, Includes: Case, 120A-6 Dial Caliper, C604R-6 Spring Tempered Precision Rule, T436.1XRL-1 Outside Micrometer w/Carbide Faces
68150546	Micrometer Set, 14pc., Solid-Rod Inside, 2- 12" Range
68153296	Dial Indicator, 25 Series AGD Group 2
68152486	Screw Pitch Gages, 28 Blades
6499001130	Dial Gage Holder Magnetic Base, 6mm, 8mm, 3/8" & Dovetail
01031558	Combination Drill & Countersink Set, Min. Trade Size #1, Max. Trade Size #5, End Type Single, Cutting Edge Style Plain, High Speed Steel, Angle 60
7201335298	End Mill Sets, Square End, Minimum Mill Diameter (Inch): 3/16 - Maximum Mill Diameter (Inch): 3/4 Number of Flutes: 2; 4, High Speed Steel
56207996	Ruler, Steel, Flexible, 6", 4R Graduation Style, Graduation (Inch): 1/64", 1/32", 1/16", 1/8"
7581810	Double Point Scriber, Straight Point, Bent Point, Aluminum, 9-1/2" OAL
09904905	Combination Square, 4pcs, 12", 4R Graduation Style, Graduation (Inch): 1/64, 1/32, 1/16, 1/8
43330295	Electrician Carbide Tipped Hole Saw Kit Cutting Diam: 7/8 in, 1 1/8 in, 1 3/8 in, 1 3/4 in, 2 in, 2 1/2 in
72A12QSCLCR3	Boring Bar, A12Q SCLCR3
72CCMT3251UD52	Diamond Carbide Insert, CCMT 32.51 UD52 Grade, TiCN Coated



68150546



68153296



68152486



6499001130

HIGH DEMAND



56207996



7201335298



09904905



ENGINEERING

Power & Pneumatic Tools

Part Number	Description
115DCF883M2	Impact Wrench Kit, 3/8in, Cordless, 20V, 2 Batteries, Charger, & Case
383231C	Wrench, Air Impact Tool, 1/2in, Square Drive
46DDS181A01	 Drill/Driver Kit, 18V, 1/2" Chuck, Includes 2 Batteries, Charger, & Case
115DWE402	Angle Grinder, 4-1/2in, 120V
4655541	Die Grinder, Right Angle, .4 HP (Dynabrade)
4655521	Die Grinder, Straight-Line Aluminum Housing, .3 HP (Dynabrade)
46CP7125	Scaler, Needle, 2 sets Needles, 1/4in Inlet
46840159860	Needle Set, 19 Piece. 1/8in
495651931	Sawzall Reciprocating Saw, 12 Amp, 1-1/8in Stroke, with Case
49548004184	Blades, Sawzall, Ice Hardened, 6in x 3/4in 18 TPI * Pack of 5
49548004188	Blades, Sawzall, Ice Hardened, 9in x 3/4in 18 TPI * Pack of 5
495262922	Bandsaw, M18 Cordless Kit, 3-1/4in Capacity, 18V, Charger & Case



115DCF883M2



383231C



46DDS181A01



4655521



495262922



4655541



46CP7125



115DWE402



495651931



Don't see what you are looking for?

Contact your Rayco Rep for more information regarding the products in this category.

“Right Away - Yours”

Contract Availability



FEDMALL



GSA ADVANTAGE

ENGINEERING

Locks

Product Number	Description
ELECTROMECHANICAL	*Contact us for more information on Stand Alone Electronic Lock Systems*
EZ Series Keypad Locks	*Contact us for more information on EZ Series Keypad Locks Systems*
70919000026D41	5 Button Push Button Lock, Oval
70103126D41	Lock, Simplex, 5-Button Vertical
70013258	Simplex Pushbutton Lock w/out Key Override, Standard
43D1610	Heavy Duty Door Closer
70C646A626	Falcon 9/16in. Marine Radius Latch
70APEX2000	Heavy-Duty Exit Device
70A5200	Padlock, Solid Steel, 1-1/8in. Boron Shackle, 6 pin APTC14 Cylinder, Keyed Alike
70101126D41	Lock, Simplex 1000 Series, Push Button, Combination Entry, Interior Combination Change
70500KABRKLN	Keyed Padlock, Single Bumper, Breakaway Shackle, Shackle Dia. 9/32 in, Keyed Alike
706835KAGRN	Padlock, Master Lock, KA, Hi-Vis, Green, 1/4, 2 Keys, Keyed Alike
70A1106KAORJ	Lockout Padlock, KA, Orange, 1/4in
70A1106KAPRP	Lockout Padlock, KA, Purple, 1/4in
70920000026D41	Kaba Simplex Cypher Lock 1-3/8in - 1-1/2in Thickness, Pin Access Lock
70BP450KA850	Brass Padlock, All Keyed The Same
701KALF	Padlock, Master Lock, Non Rekeyable, Laminated Steel, Opens with Key No. 2008
59JDHS	Door Knob, Stainless Steel, Non Locking, Joiner Door Latch Set
308CA	Door Knob, Satin Nickel, Featuring Smartkey
470BLC0432D	Commercial Grade 2 Bumpstop Knob, 6 Pin, Schlage C Compatible Cylinder, Stainless Steel Latch Bolt, Does Not react to Impact from Bumb Key/Tool



ELECTROMECHANICAL



EZ Series Keypad Locks



70BP450KA850



308CA



70103126D41



43D1610

70C646A626

70APEX2000



70919000026D41



ENGINEERING

Key Blanks

Part Number	Description
701092	1092 Key Blank
701176	1176 Key Blank
701179	1179 Key Blank
70A1114A	A1114A Key Blank
70AM3	AM3 Brass Key Blank
701145A	1145A Key Blank
701533	1533 Key Blank
701653	1653 Key Blank
70997X	997X Key Blank
701092NR	1092NR Key Blank



* Various Styles are Available. Ask a Rayco Rep for more information! *

Please Include The Following When Ordering Key Blanks:

Original Manufacturer

ex: Alba
Best
Cole
Curtis
Dominion
Ilco
Kwikset
Orion
Schlage
Yale
ETC...

Purpose- To Fit

ex: Padlock
Door Lock
Tool Case
Safe
Vehicles
ETC...

Material/ Finish:

Bronze
Nickel Plated
Nickel Silver

Manufacturer Number

*If Available

Part Number	Description
70511	Key Box, Emergency , Red Steel Construction, 2 Keys - Keyed Alike



70511

“Right Away - Yours”

Contract Availability



FEDMALL

GSA ADVANTAGE

ENGINEERING

Engravers



Part Number	Description
41RAYJET50KIT	<p>RayJet 50 Desktop Laser Engraving System, 18in x 12in Table, with Software Autofocus, Laser Pointer, 2" Precision Lens and Warranty 24 months (subject to warranty conditions). Available in 12- 50 Watts</p> <p>*Please Specify Desired Wattage When Ordering*</p> <p>Includes:</p> <ul style="list-style-type: none"> - Air Assist - Downdraft Honeycomb Cutting Table - Cylindrical Engraving Device - Laser Control Station with Graphics Software - Atmos Nano Filtration System - 1 day Installation and Training - 1 year Priority Phone Support



Part Number	Description
41SPEEDY300KIT	<p>Speedy 300 CO2 Platform Laser Engraver, 29in x 17in Table, Deep Cabinet Design, Floor Stand, Red Dot Pointer, Shielded Optics, Harsh Environment Kit, Auto Focus, USB Interface, Connecting Cables, Optics Cleaning Kit, 1 Year Chassis, 2 Year Laser Tube Warranty, Available in 12-120 Watts</p> <p>*Please Specify Desired Wattage When Ordering*</p> <p>Accessories Included:</p> <ul style="list-style-type: none"> - Atmos Mono Filtration Cart with Dual Hose Kit - Complete Laser Operating System with Pre-Installed Drivers and Graphics - Downdraft Honeycomb Cutting Table - Rotary Fixture - On-site Installation and 1 Day Training - 1 Year Priority Phone Support



Part Number	Description
41SPEEDY300FLEXXKIT	<p>Speedy 300 CO2/Fiber Flexx Platform Laser Engraver, 29in x 17in Table, Deep Cabinet Design, Floor Stand, Red Dot Pointer, 2.85" Precision Lens, Shielded Optics, Auto Focus, USB Interface, Connecting Cables, Optics Cleaning Kit, 1 Year Chassis, 2 Year Laser Tube Warranty, Available in 12-120 Watts CO2, and 10-50 Watts Fiber</p> <p>*Please Specify Desired Wattage When Ordering*</p> <p>Accessories Included:</p> <ul style="list-style-type: none"> - Atmos Mono Filtration Cart with Dual Hose Kit - Complete Laser Operating System with Pre-Installed Drivers and Graphics - Downdraft Honeycomb Cutting Table - Rotary Fixture - On-site Installation and 1 Day Training - 1 Year Priority Phone Support

Other Options & Packages Available.

Ask about other accessories for these engravers.

Additional Engraving packages also Available on the following Contracts. Call for details



Part Number	Description
41SPEEDY100	<p>Speedy 100 Laser Platform, 40 Watt, 24in x 12in Table, Deep Cabinet Design, Floor Stand, 2.0 Precision Lens, 24 Month Warranty.</p> <p>Accessories Included: Atmos Mono Filtration / Rotary Fixture / Complete Laser Operating System with Pre-Installed Drivers and Graphics / Downdraft Honeycomb Cutting Table / 1 On-site Installation and 1 Day Training</p>

Part Number	Description
412424KIT	<p>Vision 2424 Model, with 1/4 Top Load Spindle, T-Slot Table, Series 4 Controller, Inch Edge Guides, Vision Pro 9 Software, Laptop, with Windows Includes Installation/ Owners Manual, Vision, Pro software Accessory Kit, Table Accessory Kit, and One Day On-Site Installation and Training</p>



TO ORDER

Call: 1-757-431-0698

email: RAYCO@RAYCOSUPPLY.COM

Visit our website: RAYCOSUPPLY.COM

ENGINEERING

Engraving



41314



41316



415266



4131711



4121771

Part Number	Description
41314	Brass, Trophy; 12" x 24" x .020"
41316	Brass, Black Enamel; 12" x 24" x .020"
4160131	Brass Black Enamel Gloss Laserable 12" x 24" x .016"

Part Number	Description
415266	Alumamark, Satin Silver, 12" x 20" x .020" *Box of 5 Sheets*
415252	Alumamark, Satin Brass, 12" x 20" x .020" * Box of 5 Sheets*
415285	Alumamark, Mirrored Gold, 12" x 20" x .020" *Box of 5 Sheets*
4105974	DuraBlack, Matte, Aluminum, 12" x 20" x .020" *Box of 5 Sheets*

Part Number	Description
41PLEX14	Plexiglass, Laserable, Clear 24" x 48" x 1/4"
41PLEX18	Plexiglass, Laserable Clear 24" x 48" x 1/8"

Part Number	Description
Varies	Blank Solid Wood Plaques, Special Sizes, Types, and Edges Available

Part Number	Description
4131711	Combo Shear, 12in, Plastic & Metal
4131716	Upper Replacement Blade for Shear
4131733	Lower Replacement Blade for Shear
4121771	Engraving Safety Shear VA10-110V US, 24 1/2" Wide, Cuts Plastic and Metal

Roman Cove



Bevel



Radius



Cove



Shield



Rectangle

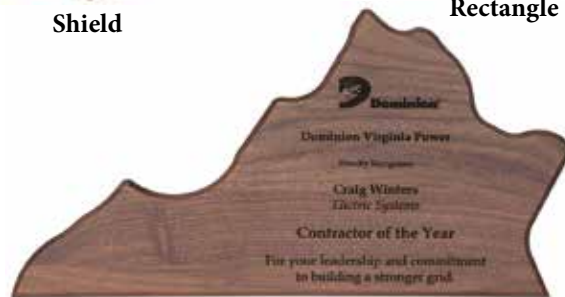

State

"Right Away - Yours"

Contract Availability













FEDMALL



GSA ADVANTAGE

ENGINEERING









LASERABLE PLASTICS

Part Number	Description
41LZ901	 Black on White, Laserable Sheet; 24" x 48" x 1/16"
41LZ902	 White on Black, Laserable Sheet; 24" x 48" x 1/16"
41LZ903	 Red on White, Laserable Sheet; 24" x 48" x 1/16"
41LZ904	 Blue on White, Laserable Sheet; 24" x 48" x 1/16"
41LZ905	 Green on White, Laserable Sheet; 24" x 48" x 1/16"
41LZ906	 Yellow on Black, Laserable Sheet; 24" x 48" x 1/16"
41LZ916	 White on Red, Laserable Sheet; 24" x 48" x 1/16"
41LZ917	 White on Blue, Laserable Sheet; 24" x 48" x 1/16"
41LZ919	 White on Green, Laserable Sheet; 24" x 48" x 1/16"
41LZ990M	 Brushed Gold on Black, Laserable Sheet; 24" x 48" x 1/16"
41LZ993	 Glossy Silver on Black, Laserable Sheet; 24" x 48" x 1/16"
41LZ994	European Gold (Smooth) on Black, Laserable Sheet; 24" x 48" x 1/16"

Part Number	Description
41896F	 Military Ribbon Bar w/ Adhesive Back & Clutches, Box of 100
41GT40P	Pre-Assembled Magnetic Gripper
4196800	Bulldog Clips w/ Adhesive Back, Bag of 100
412001236	Tape, Clear, Double Sided, 2" Wide x 36 yards
414085	Tape, Polyurethane Foam, Double Sided, 1/2" x 72 yards x 1/32"
413046130M	Gravoxide for Brass
41999127	Gravo-Bond Liquid Bond
4131086	Cermark, Metal Marking Material, Aerosol Can



ROTARY PLASTICS

Part Number	Description
41TM01	 Black on White, Rotary Sheet; 24" x 48" x 1/16"
41TM02	 White on Black, Rotary Sheet; 24" x 48" x 1/16"
41TM03	 Red on White, Rotary Sheet; 24" x 48" x 1/16"
41TM04	 Blue on White, Rotary Sheet; 24" x 48" x 1/16"
41TM05	 Green on White, Rotary Sheet; 24" x 48" x 1/16"
41TM06	 Yellow on Black, Rotary Sheet; 24" x 48" x 1/16"
41TM16	 White on Red, Rotary Sheet; 24" x 48" x 1/16"
41TM17	 White on Blue, Rotary Sheet; 24" x 48" x 1/16"
41TM19	 White on Green, Rotary Sheet; 24" x 48" x 1/16"
41TM90	Brushed Gold on Black, Rotary Sheet; 24" x 48" x 1/16"
41M93	Silver on Black, Rotary Sheet; 24" x 48" x 1/16"

Part Number	Description
41NTBGBBC	 Name Tag, 1" x 3", Gold on Black w/ Bevel & Clutch back
41962601BG	Name Tag, 1" x 3", Black on Gold Clutchless
41NTBW13BC	 Name Tag, 1" x 3", Black on White w/ Bevel & Clutch Back
41NTBLW13BC	Name Tag, 1" x 3", Blue on White w/ Bevel & Clutch Back



TO ORDER

Call: 1-757-431-0698

email: RAYCO@RAYCOSUPPLY.COM

Visit our website: RAYCOSUPPLY.COM

ENGINEERING

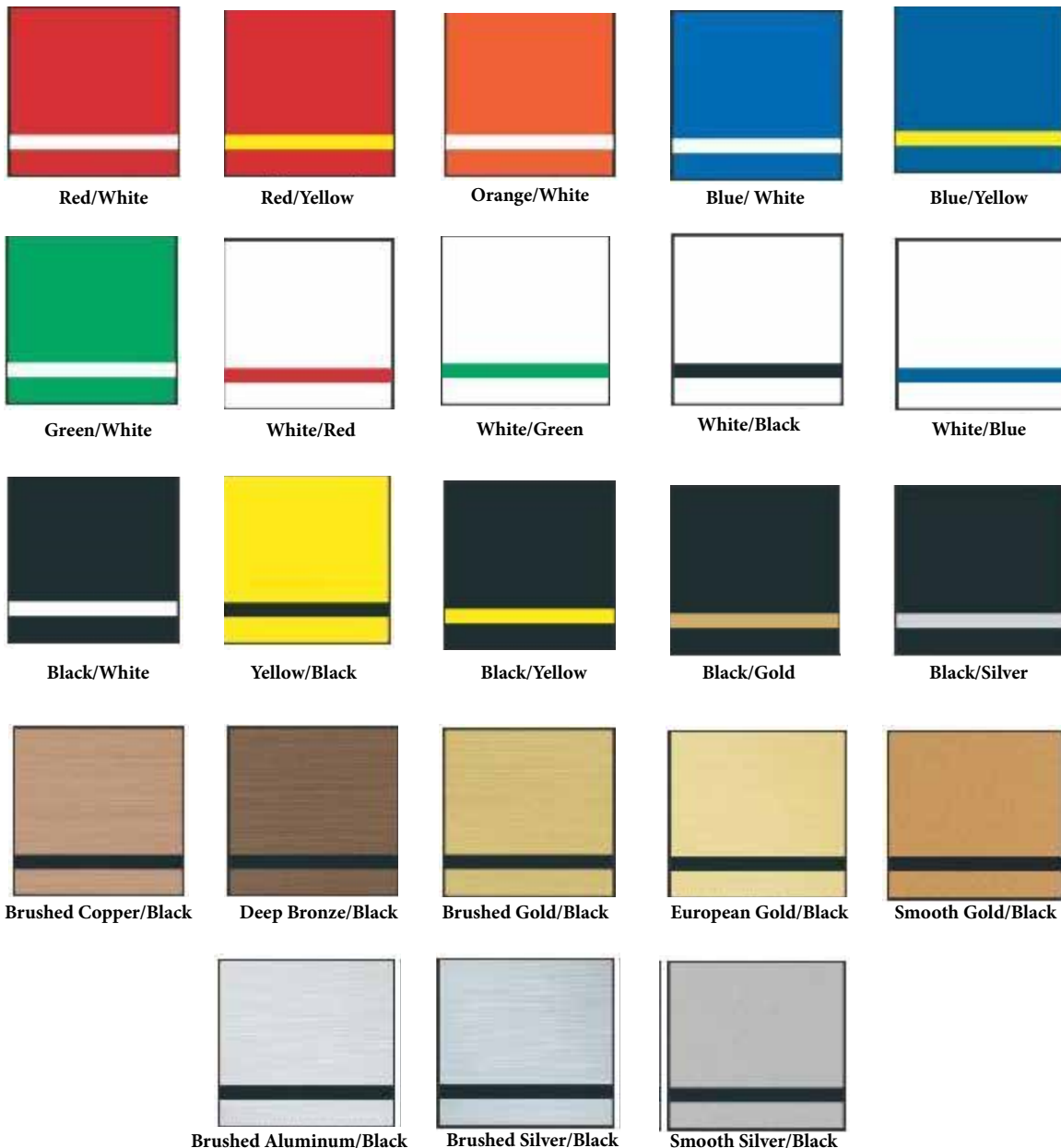

***** Note For All Engraving Sheets *****

The **SECOND** color listed will show once engraved

ex: 'Black/ White' or 'Black on White' will look like a plain black sheet until engraved.

The engraving will then show in white.



Don't see what you are looking for?

Contact your Rayco Rep for more information regarding the products in this category.

"Right Away - Yours"

Contract Availability



FEDMALL

GSA ADVANTAGE

ENGINEERING

Wood Working



Part Number	Description
461791317K	Jointer, 1HP, 115V 54HH 6in with Helical Cutterhead 15" x 15" x 2.5"

Part Number	Description
421791315	Planer 5HP, 1 Phase, 230V 26" L x 36-5/8" W x 41-3/8" H



7292100



Part Number	Description
421791001K	Tablesaw, 1-3/4 HP, 115V 52in Rip 43" W x 83" L x 44" H

Part Number	Description
421791500	Bandsaw 3HP, 1 Phase, 230V, 30-1/4" L x 34-3/8" W x 71" H

Part Number	Description
72158997	Router Motor, 3.25 HP
46159486	Router Table Package, 24 x 32, V2 420 Router Lift
7292100	 Router bit Set, 26 pc
115DCS373P2	Circular Saw Kit, Cordless, 20V
115DW9155	Saw Blades, 6-1/2in 16 TPI
114ROS10	Orbit Sander, Random 5in
40834037	Sanding Disc, 5in 150 grit * Pack of 50
44985052	Paint Brush, Foam, 2in * Case of 50
44915002	Paint Brush, Bristle, 2in * Case of 24



72158997



46159486



115DCS373P2



44985052



44915002



Don't see what you are looking for?
Contact your Rayco Rep for more information
regarding the products in this category.



ENGINEERING

Flap Discs

Part Number	Description
4037626	Flap Disc, Zirconia Alumina, 60 Grit, 4-1/2" x 5/8"-11, Type 29 (angled flaps)
4036626	Flap Disc, Zirconia Alumina, 60 Grit, 4-1/2" x 7/8, Type 29 (angled flaps)

Abrasives

Type 27 Depressed Center Grinding Wheels for Angle Grinders

4021468	Grinding Wheel, Type 27, A24R, 4-1/2" x 1/4" x 5/8"-11 (main application- structural steel, iron, weld, etc.)
4021467	Grinding Wheel, Type 27, A24R, 4-1/2" x 1/4" x 7/8" (main application- structural steel, iron, weld, etc.)
4028464	Grinding Wheel, Type 27, AL36N, 4-1/2" x 1/4" x 5/8"-11 (main application- aluminum, brass, copper)
4024464	Grinding Wheel, Type 27, AL36N, 4-1/2" x 1/4" x 7/8" (main application- aluminum, brass, copper)
4011468	Grinding Wheel, Type 27, ZA24R, 4-1/2 x 1/4 x 5/8-11 (main application: stainless steel, high tensile alloys)
4011467	Grinding Wheel, Type 27, ZA24R, 4-1/2 x 1/4 x 7/8" (main application: stainless steel, high tensile alloys)



Type 27 Depressed Center Cut-Off Wheels for Angle Grinders

4028427	Cut-Off Wheel, Type 27, A24R, 4-1/2" x 3/32 x 5/8-11 (main application- structural steel, iron, weld, etc.)
4024427	Cut-Off Wheel, Type 27, A24R, 4-1/2" x 3/32 x 7/8 (main application- structural steel, iron, weld, etc.)
4014438	Cut-Off Wheel, Type 27, ZA24R, 4-1/2" x 3/32 x 5/8-11 (main application: stainless steel, high tensile alloys)
4014437	Cut-Off Wheel, Type 27, ZA24R, 4-1/2" x 3/32 x 7/8 (main application: stainless steel, high tensile alloys)
4028436	Cut-Off Wheel, Type 27, C24R, 4-1/2" x 3/32 x 5/8-11 (main application- aluminum, brass, copper)
4024436	Cut-Off Wheel, Type 27, C24R, 4-1/2" x 3/32 x 7/8 (main application- aluminum, brass, copper)



Type 1 Cut-Off Wheels for Angle Grinders

4051407	Cut-Off Wheel, Type 1, A60T, 4-1/2" x .045" x 7/8" (main application- structural steel, iron, weld, etc.)
4051405	Cut-Off Wheel, Type 1, A60T, 4" x .045" x 5/8" (main application- structural steel, iron, weld, etc.)
4063405	Cut-Off Wheel, Type 1, AL46N, 4" x .040" x 5/8" (main application- aluminum, brass, copper)
4063407	Cut-Off Wheel, Type 1, AL46N, 4-1/2" x .040" x 7/8" (main application- aluminum, brass, copper)
4053415	Cut-Off Wheel, Type 1, TA46T, 4" x 1/16" x 5/8" (main application: stainless steel, high tensile alloys)
4053417	Cut-Off Wheel, Type 1, TA46T, 4-1/2" x 1/16" x 7/8" (main application: stainless steel, high tensile alloys)



Type 1 Small Diameter Cut-Off Wheels for Die Grinders & P-Grinders

4053303	Cutting Wheel, Small Dia., TA60T Type 1, 3" x .035" x 3/8" (main application- structural steel, iron, weld, etc.)
4053301	Cutting Wheel, Small Dia., TA60T Type 1, 3" x .035" x 1/4" (main application- structural steel, iron, weld, etc.)
4051314	Cutting Wheel, Small Dia., A60T Type 1, 3" x 1/16" x 3/8" (main application- structural steel, iron, weld, etc.)
4051312	Cutting Wheel, Small Dia., A60T Type 1, 3" x 1/16" x 1/4" (main application- structural steel, iron, weld, etc.)
4093303	Cutting Wheel, Small Dia., ZA60T Type 1, 3" x .035" x 3/8" (main application: stainless steel, high tensile alloys)
4093301	Cutting Wheel, Small Dia., ZA60T Type 1, 3" x .035" x 1/4" (main application: stainless steel, high tensile alloys)
4093313	Cutting Wheel, Small Dia., ZA46T Type 1, 3" x .035" x 3/8" (main application: stainless steel, high tensile alloys)
4093311	Cutting Wheel, Small Dia., ZA46T Type 1, 3" x .035" x 1/4" (main application: stainless steel, high tensile alloys)

Contract Availability

"Right Away - Yours"



FEDMALL



GSA ADVANTAGE

ENGINEERING

Part Number	Description
4093004020	Sandpaper, A/O, Sheet 9"x11", 80 Grit
4093001120	Sandpaper, A/O, Sheet 9"x11", 100 Grit
4093001520	Sandpaper, A/O, Sheet 9"x11", 120 Grit
4093001820	Sandpaper, A/O, Sheet 9"x11", 150 Grit
4093005111	Sandpaper, A/O, Sheet 9"x11", 180 Grit
4094022320	Sandpaper, S/C, 9"x11", Waterproof Sheet, 220 Grit
4094022620	Sandpaper, S/C, 9"x11", Waterproof Sheet, 320 Grit
4094023320	Sandpaper, S/C, 9"x11", Waterproof Sheet, 600 Grit
4029359	Sandpaper, 9"x11" 120 grit* Box of 50
4029361	Sandpaper, 9"x11" 80 grit * Box of 50
4029353	Sandpaper, 9"x11" 320 grit * Box of 50
4029356	Sandpaper, 9"x11" 220 grit * Box of 50

Part Number	Description
464568A17	Arbors & Mandrels for Abrasive Cutoff Wheels 3/8" Arbor, 1/4" Shank
4568A18	Wheel Arbor for 3/8" Arbor Hole, 1/4" Maximum Wheel Thickness, 3/8" Shank Diameter

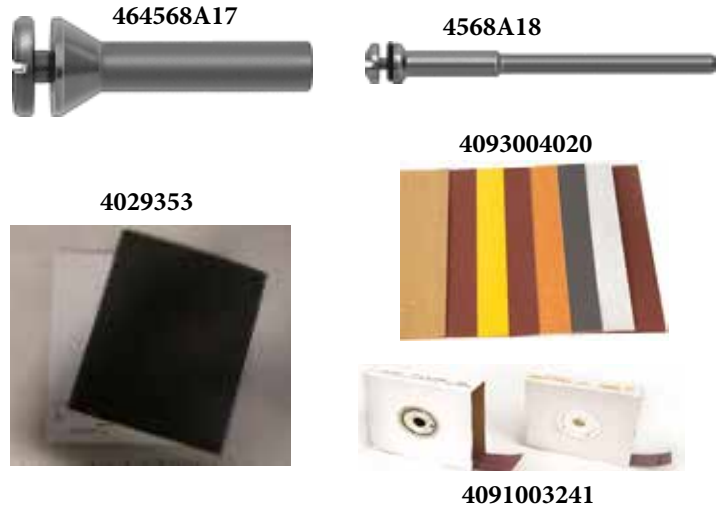

Part Number	Description
404606	Cone, Abrasive, 2" x 3" x 5/8-11" A16 T16
404607	Cone Abrasive, 2-3/4" x 3-1/2" x 5/8-11" A16 T16
404609	Cone, Abrasive, 1-1/2" x 3" x 5/8-11" A20 T17
404612	Cone, Abrasive, 1-1/2" x 2-1/2" x 5/8-11" A20 T17
404616	Cone, Abrasive, 2" x 3" x 5/8-11" A16 T17
404632	Cone, Abrasive, 1-1/2" x 2-1/2" x 5/8-11" A20 T18R
4091003241	Shop Roll, A/O, 2"x50yds, 80 Grit
40311137	Shop Roll, A/O, 2"x50yds, 120 Grit

Part Number	Description
4083007389	Disc Roll, 5", Gold Paper Stearated, 80 Grit
4083005989	Disc Roll, 5", Gold Paper Stearated, 100 Grit
4083006089	Disc Roll, 5", Gold Paper Stearated, 120 Grit
4083006289	Disc Roll, 5", Gold Paper Stearated, 180 Grit
4083006389	Disc Roll, 5", Gold Paper Stearated, 220 Grit
89474548	Disc, Sanding, 5", Silicone Carbide, Adhesive Backing, 100 Grit
93113256	Disc, Sanding, 5", Silicone Carbide, Hook & Loop Backing, 400 Grit, with Vacuum Holes



Don't see what you are looking for?
Contact your Rayco Rep for more information regarding the products in this category.



ENGINEERING



Part Number	Description
065TB10	Scratch Brush, Toothbrush Style, 3 x 7-1/2" Trim Length, 7-7/8 OAL



Part Number	Description
4044053	Scratch Brush, Curved Wood Handle, 14" Block, 7/8" Block Width, 3 x 19 Steel, 5-1/2" Brush Length, 1-3/16" Trim Length



Part Number	Description
4044063	Scratch Brush, Wood Shoe Handle, 10" Block, 1-1/8" Block Width, 4 x 16 Steel, 5" Brush Length, 1-3/16" Trim Length



Part Number	Description
4085130	Brush, Scratch, Wire, SS, 10"



Part Number	Description
80444167	Scratch Brush, Small Hand, Curved Wood Handle, 7-1/2" Block, 1/2" Block Width, 3 x 7 Stainless Steel, 1/2" Trim Length



Part Number	Description
4044088	Brush, Acid/Flux, Cylindrical Aluminum Handle, 5-3/4" OAL, 5/16" Width, 3/4" Trim Length



Part Number	Description
4044067	Scratch Brush, Wood Block Type, 7-1/4" Block, 2-1/4" Block Width, 6 x 19 Steel, 7" Brush Length, 1-5/8" Trim Length



Part Number	Description
4085100	Brush, Scratch, Wire, 10"

"Right Away - Yours"

Contract Availability



FEDMALL



GSA ADVANTAGE

ENGINEERING

3D Printing

Consumables

Rayco Supply now provides consumables for 3D Printers.

We can accommodate these popular Filament types along with many others to meet your 3D Printing needs.

If you don't see the material you are looking for, please contact Rayco Supply and we will be happy to locate what will work best for your application.



3D Printer Filament Types

Filament	Characteristic	Best Suited For	Strength 1-5	Durability
PLA	All-natural and Biodegradable	Prototypes and products	3	2
ABS	Strong and durable	End-use parts and casings	3	3
PLA Plus +	Very durable biopolymer	Vibration absorbing and less brittle version of PLA	3	3
Nylon	Extremely durable and flexible, low friction.	High impact or high stress parts - fantastic all-rounder	4	5
PETG	Extremely durable and flexible	High impact or high stress parts	4	4
ASA	Strong, UV resistant alternative to ABS	Outside casings, covers and devices.	4	3
Polycarbonate	Stiff, tough and shatter resistant	Rigid components, strong alternative to glass.	4.5	3
Flexible PLA	Flexible biopolymer	Flexible, durable parts	2	4
TPU	Flexible polymer	Flexible, very durable parts	2.5	5
HIPS	High impact resistance & soluble support	Alternative to ABS, or used as a limonene dissolvable support structure	3	3
PVA	Water soluble support	Easily dissolves in water	2	2
Break-Away	Break-off support	A no mess alternative to dissolvable support materials products	2.5	2.5
Nylon Plus	Glass-reinforced Nylon	Excellent abrasion resistance and low friction	4	5
Carbonyte	Carbon Fibre Nylon	Excellent strength and stiffness	5	5
Floss (Cleaning)	Cleans out residue and carbon buildup	Saves time, prevents nozzle blockages	N/A	N/A
PMMA	All-natural and Biodegradable	Prototypes and products	3	2



Safety Storage Cabinets

LYON[®]

Rayco Supply can accommodate a wide variety of Flame Lockers to meet your storage needs.

Contact us for details on how we can provide you with the best possible solution to safely store your materials.



ENGINEERING

Material Handling



Pallet Truck

Ratchet Straps



Manual Hoists



Electric Hoists



Drum Dollies



Part Number	Description
43622563	Strapping Kit, Steel

AMSAFE
BRIDPORT



Fire Containment Bag
Up to 1800deg F



Air Cargo Tyvek Covers -
Standard, Advanced (thermal protection) or
Extreme (with insulative fleece), Pharmaceutical



Pallet Nets

Approved by US DoD Air Transportability Agency
(ATTLA)



Fire Containment System
Up to 6hrs



Don't see what you are looking for?
Contact your Rayco Rep for more information
regarding the products in this category.



Helicopter Under - Slung Cargo Nets
(HUSTLE)

“Right Away - Yours”

Contract Availability



FEDMALL

GSA ADVANTAGE

ENGINEERING

Storage



Available in the following Widths:

- Slender 22-13/16" W
- Standard 30" W
- Medium 36-3/8" W
- Extra 44-3/8" W
- Double 59-5/8" W



Pre - Engineered Modular Cabinets

Available in the following Heights:

- Desk 26-7/8" H
- Table 30-1/8" H
- Bench 33-1/4" H
- Mid- Range 37-3/16" H
- Counter 44-1/4" H
- Eye-Level 59-1/4" H



Available in the following Colors:

- Dove Gray
- Putty
- Black
- Green
- Blue
- Ash
- Red



Multiple Drawer Size Options available- contact us for more information!

Available with or without drawer layout kits



Bulk Storage Rack Systems

Available in 60" Width, 72" Width, and 96" Width.

Shelves available with Particle Board Decking,
Steel Ribbed Decking, or Wire Decking



All Welded 4 Shelf Storage Cabinets

1,450 Lbs Storage per shelf

Available in the following size options:

- 36" w x 21" d x 82" h
- 36" w x 24" d x 82" h
- 48" w x 24" d x 82" h
- 60" w x 24" d x 82" h

Available colors: Dove Gray, Putty, Black & Blue



TO ORDER

Call: 1-757-431-0698

email: RAYCO@RAYCOSUPPLY.COM

Visit our website: RAYCOSUPPLY.COM

ENGINEERING

Custom Shipboard Furniture



Rayco Supply offers completely customizable furniture options built to fit any room no matter the unique dimensions of the space.

Contact us to have a Sales Representative help put together a custom furniture arrangement that will best accommodate your needs.



“Right Away - Yours”

Contract Availability



FEDMALL



GSA ADVANTAGE

Ladder Treads

Type F Tread - Specify part 804-860041 Type F

- Fabricated from 6061-T6 alloy, mill finish
- Top surface can be provided with rectangular punch or optionally unpunched
- End plates can be provided with or without holes.
- Specify dimensions when ordering.

Type I Full Tread- Specify Part 804-860041 Type I

- Extruded aluminum, 6061-T6, mill finish
- Abrasive compound filler is integrated into the extruded top surface to provide safe and long-lasting non-slip coverage. Punched end hole for mounting treads are provided unless no end holes are specified when ordering
- Manufactured in accordance with MIL-T-24634
- Specify Dimensions when ordering.

Type II Cap Treads - Specify part 804-860041 Type II Cap

- Extruded aluminum, 6061-T6, mill finish
- Aluminum oxide grit bonded with synthetic resin set in grooved top surface
- Manufactured in accordance with MIL-T-24634
- Countersunk holes provided to mount to existing treads.
- Specify dimensions when ordering.

Type F



Type II

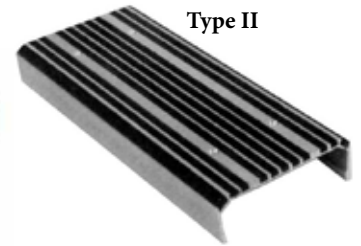

Type I

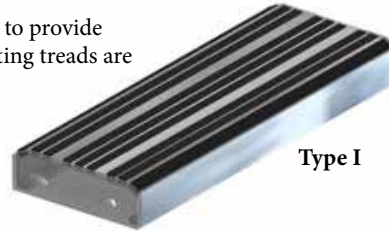

Ladders

- Contact us for details on how to order -

- Inclined Ladders - For Access Between Decks. Compact

and secure for tight passageways. Fixed or

Removable handrails

- Ladder Chutes - Built to Buships specifications.

For personnel traffic and easy movement of material

Vertical Ladders - Several Styles Available

* Aluminum- Built to BUSHIPS 805-1360280, 6061-T6,

12in wide and length to suit, tread spacing 12in

* Steel - Built to BUSHIPS S1604-860091, Galvanized

12in wide and length to suit, tread spacing 12in

* Stainless Steel- Built to BUSHIPS S1604-860091

12in wide and length to suit, tread spacing 12in

* Fiberglass (GRP) - IAW 803-5184098

12in wide and length to suit, tread spacing 12in

- More Options -

- Special Widths

- Mounting Clips

- Slip Fittings

- Hardware

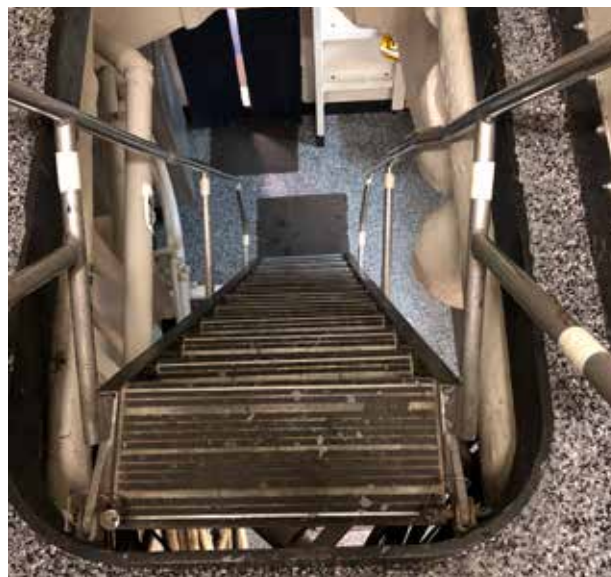

TO ORDER

Call: 1-757-431-0698

email: RAYCO@RAYCOSUPPLY.COM

Visit our website: RAYCOSUPPLY.COM

Toggle Pins & Securing Ladder Pins

Part Number	Description
58PN1S0380200	Toggle Pin, Stainless Steel, 3/8in x 2in (grip), 3-1/4in OAL
58PN1C0630175SS	Toggle Pin, Stainless Steel, 5/8in x 1-3/4in (grip), 3-1/2in OAL

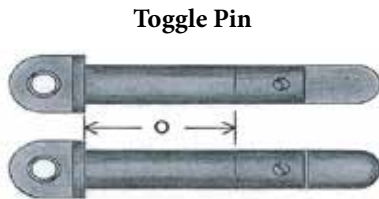

Part Number	Description
4523413438	Securing Ladder Pin, Steel, 3/8in x 1-3/4in, 2-3/4in OAL
4523413438SS	Securing Ladder Pin, Stainless Steel, 3/8in x 1-3/4in, 2-3/4in OAL
4523413458	Securing Ladder Pin, Steel, 5/8in x 1-3/4in, 2-3/4in OAL
4523413458SS	Securing Ladder Pin, Stainless Steel, 5/8in x 1-3/4in, 2-3/4in OAL

Toggle Pins & Securing Ladder Pins are available for custom order. Several varieties available. Note: Items are non returnable

Please Specify Size: (Diameter / Grip Range / Length)

Specify Material: (Stainless Steel 303 or 316 / Bronze / Galvanized or Plain Steel / Monel)



Don't see what you are looking for?

Contact your Rayco Rep for more information regarding the products in this category.

“Right Away - Yours”

Contract Availability



FEDMALL

GSA ADVANTAGE

Deck Grating

Punched, unpunched non-slip grating and grating panels are used for walking surfaces and storage rooms. These Panels are available in Light Series and Heavy Duty in thicknesses of 3/4 inches to 3 inches.

Technical Specifications:

- Extruded aluminum 6063-T6 in accordance with MIL-G-18015.
- Grating for ammo stowage rooms in accordance with NAVSHIPS drawing 804-2425891.
- Available in 6" wide sections to a maximum of 26' long or fabricated in panels to suit the specific requirement with end bar banding if needed.
- Heavy duty and light duty grating is available 6" wide and 3/4" to 2-1/2" high.
- Top surface can be punched with round, rectangular, square, or dogbone punch.
- Special hole patterns available upon request.

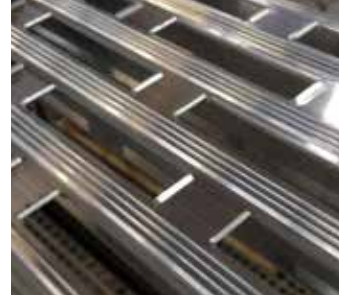

SQUARE UPSET



Ammo Magazine Deck Grating

Aluminum Deck Grating, 6005-T5 Alloy, MIL-G-18015A, Type II, 10-1/4 inch wide by 1-1/2 inch deep with upset punched 11/32 inch square holes, 11/16 inch apart.



Note: Items are non returnable

PUNCH STYLES

DOGBONE



RECTANGULAR

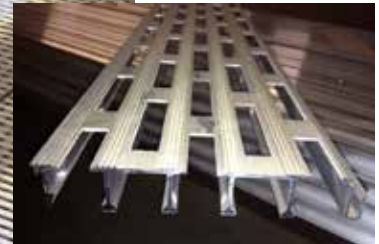

ROUND



Vent Diffusers

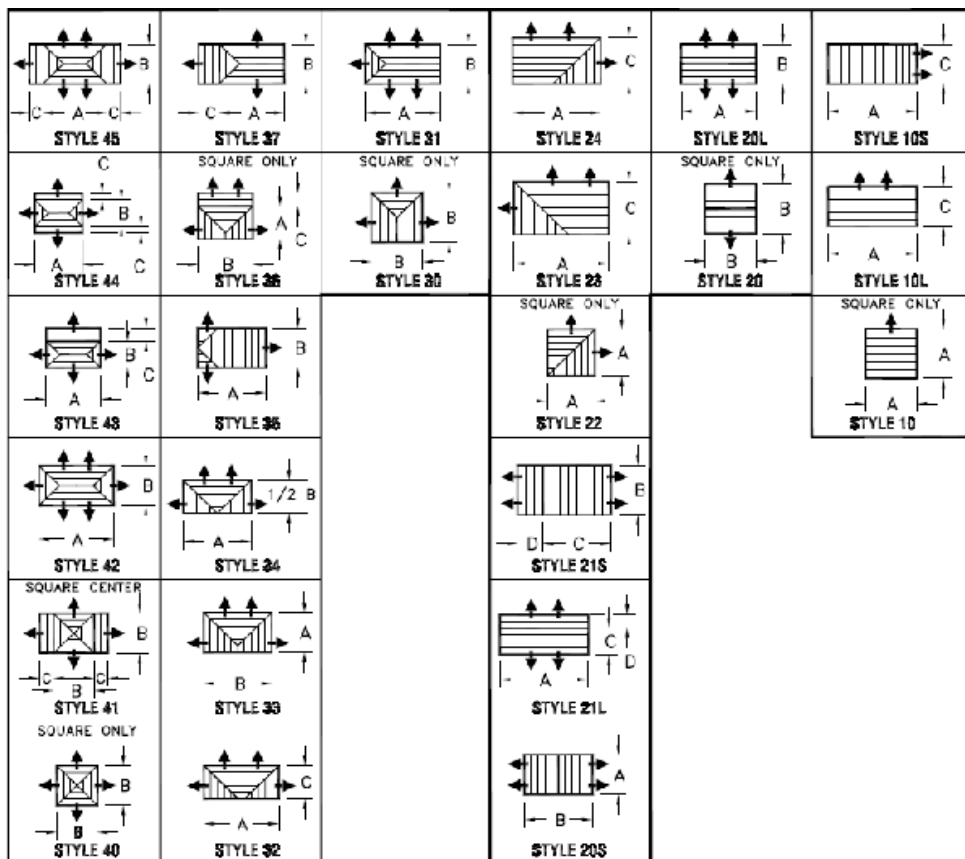

Available in Round, Square, & Rectangular in various sizes!! The table shows the most common styles for shipboard use.



All Styles Available in
STANDARD
&
SHOCK RATED
Specify construction at time of request.

Make sure to measure the space the diffuser will fit into and provide exact dimensions for proper fit.

Galley Vent Covers

Exclusively Through Rayco Supply

- Custom assembled air filtration hardware for Galley ventilation conduits.
- Reduces if not eliminates debris emitted from conduit exhaust ports.
- Contains a hinged door allowing for easy filter removal/maintenance
- Extremely durable and easy to clean.



Contact Rayco Supply to have a sales representative come out and put together a package that will work best for you.



Contract Availability

“Right Away - Yours”



FEDMALL

GSA ADVANTAGE

INSURV

Part Number	Description	Part Number	Description
561760A3	Hook, 2 Prong, J Shape, Aluminum, 1-1/2" Height, 1-1/8" Projects	RB4478212	Gloves, Disposable, Nitrile, Powdered, 8 mil, Box of 50
43P1760	Soap Holder, Stainless Steel	Varies	Rack Curtains (Multiple Colors)
43S4520	Toothbrush Holder, Stainless Steel	Varies	All Photoluminescent Markings
56S4532S	"J" Hook, Stainless Steel	Varies	Hand Wheels
56BFBIPASU	Personal Article Shelf, Universal, 9" X 3.5" X .75"	Varies	Joiner Doors & Repair Parts
44S4542	Stainless Steel Towel Bar, 18"	Varies	Lagging Materials (Hullboard, K-Flex, Pins, Dome Caps, etc
44TPHSLH	Single Roll Toilet Paper Holder	Varies	Complete Shipboard Valves
44SSST	Shampoo & Soap Shower Tray, SS	Varies	Steel Electrical Box Covers (specify size & outlets)
56G106002SN	Doorstop And Hook Assembly	Varies	Raw Metals
56G105901SN3	Door Bumper, 3in	Varies	Pipe & Tubing
48EEBDAL	EEBD Holder (Berthing)	Varies	Pipe Fittings
48EEBDH	EEBD, Stowage (Bulkhead Mount)	Varies	Cipher Locks
483EEBD	3 Unit EEBD Holder, Overhead	Varies	Repair Locker Kits
48EEBDPP	EEBD Safety Pin and Lanyard	Varies	Fan Coil Unit Bolts
43EEBDSPRK	EEBD Holder Small Parts Kit	Varies	Misc Head Parts
43DBCLGTC	Rack Light Bulb Cover w/screws	Varies	Misc Berthing Parts
43SDL3	Stall Door Latch	Varies	State Room Parts
59JDHS	Door Knob, Stainless Steel, Non Locking, Joiner Door Latch Set	43CCOL	CCOL, Compartment Check Off List, Holder, Inside
43PC119	Sound Powered Phone Cap, 17339	43CCOLMP	CCOL, Compartment Check Off List, Holder, Moisture Proof



48EEBDH



44S4542



RB4478212



56G106002SN



43PC119



Rack Curtains



561760A3



43S4520







43CCOL

Don't see what you are looking for....
 Contact your Rayco Rep for more information regarding the products in this category!!



Doors & Hinge Kits

All doors, handles, and locks are special order items. Contact your Rayco Representative for more information.

Part Number	Description
59JESIDD161	Steel QAWT Dog Bearing Kit
59JESIDD171	Steel IDWT Dog Bearing Kit
59JEADD161	Aluminum QAWT Dog Bearing Kit
59JEADD171	Aluminum IDWT Dog Bearing Kit
59JE538MKAT	 Complete Upgrade Kit for Low Hinge ATD (3 kits per door)
59JE538MKWT	 Complete Upgrade Kit for Low Hinge WTD (2 kits per door)
59JE538MKHAT	Complete Upgrade Kit for High Hinge ATD (3 kits per door)
59JE538MKHWT	 Complete Upgrade Kit for High Hinge WTD (2 kits per door)
RB3717183	 Water Tight Door Gasket
59JE262SCA	Spring Clip for Individually Dogged WTD Series DI-261
59JE269SCKS	Spring Clip for Individually Dogged QAWTD Series DI-268

Part Number	Description
591648659LHFT	Metal Door, Fume Tight, Fire Zone, Left Hand, Powder Coat Grey 803-1648659
591648659RHFT	Metal Door, Fume Tight, Fire Zone, Right Hand, Powder Coat Grey 803-1648689
5903291L	Joiner Door Type P, 26x66, w/ Frame, Roton Hinger, Latch Set, Grey, Specify Hand when ordering
5903294L	Joiner Door Type C, 26x75, w/ Frame, Roton Hinger, Latch Set, Grey, Specify Hand when ordering
59JDHS	Door Knob, S/S NonLocking, Joiner Door Latch Set



Joined and Fire Zone Doors also Available
Contact a Rayco Representative for additional information

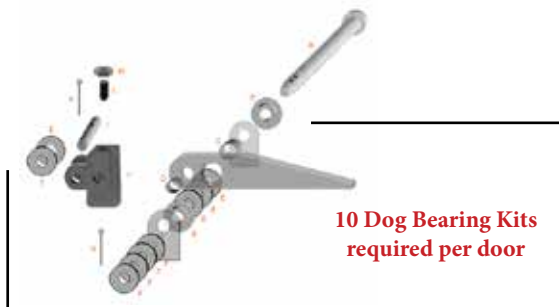
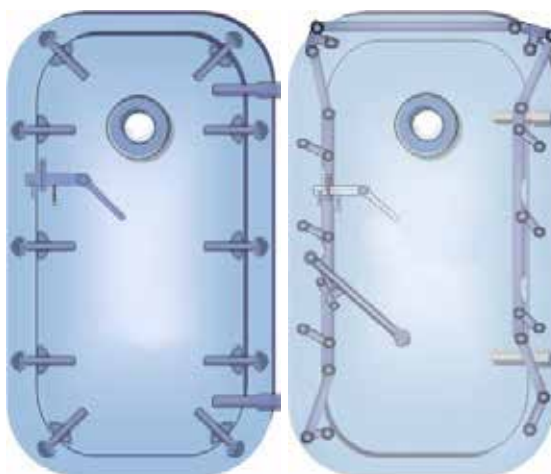

Hand Wheels

Available in Aluminum, Zinc, Steel, Bronze diameter of the wheel itself as well as the size of the stem port, the valve number if available is also very helpful. If a sample can be provided we can usually find a match.



Don't see what you are looking for?
Contact your Rayco Rep for more information regarding the products in this category.

Non - Skid

- Interior or Exterior Use
- Applied to any clean, painted surface
- Applied in temperatures as low as 40deg F
- Fast Application
- Ready as soon as applied
- Available in several widths (up to 4ft) and lengths (up to 60ft)
- Available in Black or Grey, Limited Sizes in Yellow
- Custom Sizes May Also be Available

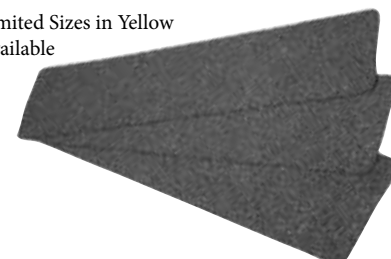
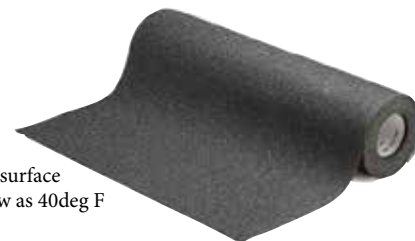

Contract Availability



FEDMALL



GSA ADVANTAGE



“Right Away - Yours”

Replacement Fixtures





Part Number	Description
447385	 Single Lever Faucet

Part Number	Description
44B0232	6" Swing Spout
44B0231	12" Swing Spout
44B0206	15" Swing Spout
44B0230	18" Swing Spout

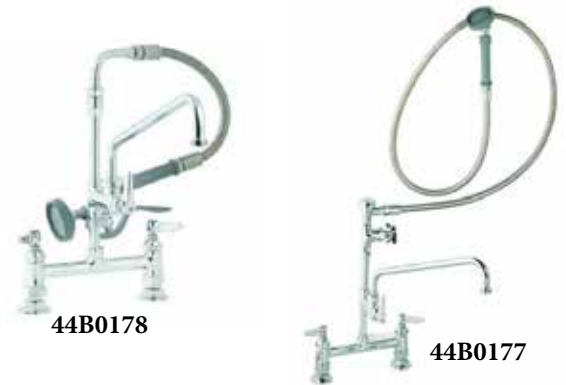
Part Number	Description
44B0178	Pre-Rinse Unit - Surface 8" Center 1/2" NPT w/ 12" Swing Spout
44B0177	Pre-Rinse Unit - Surface 8" Center 1/2" NPT w/ 12" Swing Spout Faucet & 20" Hose
44B0044H	 44" Spray Flex Hose, Replacement
44B0107	 1.42 GPM Spray Head, Replacement
44B0100	Pre - Rinse Spray w/ Auto Shut Off & 44" Hose
440155	6" Add on Faucet for Pre-Rinse, Swing Spout (44B1033)



Part Number	Description
44B0133	 Pre-Rinse Unit - Wall Mount
44B0156	 12" Add on Faucet For Pre-Rinse, Swing Spout (44B1033)



Part Number	Description
44B0221	 Faucet, 8in. Centers, Deck Mount



Part Number	Description
44B121001	Pedestal Push Back Single Glass Filler (Base of flange outlet is 10")
44B1211	Pedestal Push Back Single Glass Filler (Base of flange outlet is 4")
44B1255	Glass Filler Repair Kit



Lagging



K - Flex

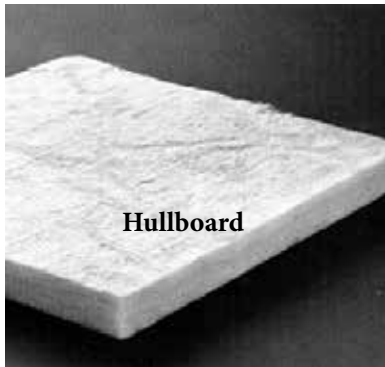

Hullboard



K - Flex Eco

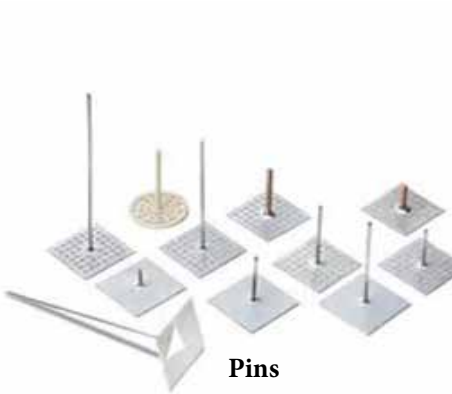

Pins



Adhesive

Part Number	Description
66GIC65033	Hull Board Faced Navy Cloth, 1" x 24" x 36", MIL-I-742, TY 1
66GIC65082	Hull Board Faced Navy Cloth, 2" x 24" x 36" MIL-I-742, TY 1
66GIC914	30-36 Adhesive, Pail, CL-1, GR-A, 1 Gallon MIL-A-3316 (for use with Hull Board)
66GIC71227	7/8" Annular Ring Anchor Bolt, Aluminum (Lagging Pin)
66GIC65931	7/8" Annular Ring Anchor Bolt, Mild Steel (Lagging Pin)
57AC707	Navy Cap, Aluminum, 7/8" (Lagging Pin Dome Caps)
66GIC71229	Navy Cap, Mild Steel, 7/8" (Lagging Pin Dome Caps)
66GIC14697	Hull Board Tape, TY-2, CL-1, 2" MIL-C-20079H
66GIC12556	Hull Board Tape, TY-2, CL-1, 3" MIL-C-20079H
66GIC44225	Hull Board Tape, TY-2, CL-1, 4" MIL-C-20079H
66GIC62543	3/4" K-Flex ECO Sheet, 36" x 48" (for use on ventilation ducts, large pipes)
66GIC64205	1" K-Flex ECO Roll, 4' x 35' (for use on ventilation ducts, large pipes)
66GIC37778	2" IPS x 3/4" K-Flex ECO Tube, 6ft. Section (for use on Pipes)
66GIC44195	3" IPS x 3/4" K-Flex ECO Tube, 6ft. Section (for use on Pipes)
66GIC63992	6" IPS x 3/4" K-Flex ECO Tube, 6ft. Section (for use on Pipes)
66GIC3552	520 Adhesive, Armstrong Quart, TY-2, CL-1 MIL-A-24179 (For use with K-Flex Eco Sheets & Tube)
66GIC28858	#84215 Fiberglass Cloth, TY-1, CL-3, White, MIL-C-20079 (For use with K-Flex Eco Tube)



Don't see what you are looking for?

Contact your Rayco Rep for more information regarding the products in this category.

"Right Away - Yours"

Contract Availability



FEDMALL

GSA ADVANTAGE

LED Bulbs & Light Covers



Part Number		Description
74FLZT5G12		12SSL, Military Grade, LED 12" Tube - BERTH/RACK Retrofit Tube
74FLZT12G18		18SSL, Military Grade, LED 18" Tube - VANITY Mirror Retrofit Tube
74FLZT12G24		24SSL, Military Grade, LED 24" Tube - GENERAL Overhead Lighting
74FLZT12G48		48SSL, Military Grade, LED 48" Tube - HANGAR BAY Overhead Lighting
74LBA1931153HT		SSL Lamp, Military Grade, WHT
74EXPAC115654060		LCS Combatant Navy Floodlight

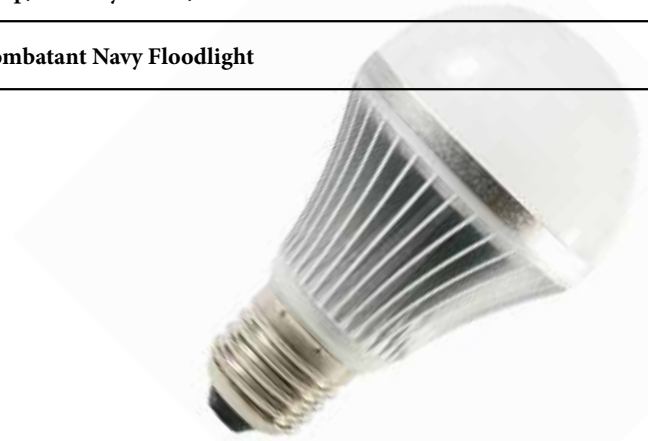

Don't see what you are looking for....
 Contact your Rayco Rep for more information
 regarding the products in this category!!

Part Number	Description
74B2064S	Lens, 1 Lamp Lighting Fixture, Work Light (Completely Clear- 100% Visibility, Non- Prismatic)
74B1707S	Lens, 2 Lamp Lighting Fixture, Work Light (Completely Clear- 100% Visibility, Non- Prismatic)
74B1708S	Lens, 3 Lamp Lighting Fixture, Work Light (Completely Clear- 100% Visibility, Non- Prismatic)
74B1467L	Lens, 1 Lamp Lighting Fixture, White Diffusing (Milky White Color)
74B1727L	Lens, 2 Lamp Lighting Fixture, White Diffusing (Milky White Color)
74B1723L	Lens, 3 Lamp Lighting Fixture, White Diffusing (Milky White Color)
74B1726L	Lens, 1 Lamp Lighting Fixture, Prismatic (White at Ends)
74B1718L	Lens, 2 Lamp Lighting Fixture, Prismatic (White at Ends)



Body Armor

4PV Concealable Vest

MEN



The 4PV (Four Panel Vest) is the latest innovation in armored protection. Four independent panels articulate to provide unparalleled mobility and protection. This easy to size platform provides a fully modular, highly adaptable and comfortable system that users want to wear.

Available Colors



Black



LAPD Navy

Contact us for Ballistic Requirements and Ordering Instructions

WOMEN



INTRODUCING THE PROPER 4PV (FOUR PANEL VEST)

COMFORT
4 panels fit better, eliminating ride-up and bunching.

MOBILITY
Panels move independently at you sit, stand or run.

PROTECTION
4 panels instead of 2 for superior side protection.

★ **PROPER**

Aegis SAPI Tactical Vest

The Aegis SAPI (Small Arms Protective Insert) plate carrier is a lightweight carrier designed for SAPI/ESAPI/Shooter cut plates. It can be worn with or without custom cut soft armor inserts. The cummerbund on the Aegis contains six pockets that will hold a range of items such as M4 and .308 magazines, pistols, and radios.



Features

- Plate Carrier
- Removable side hard plate pockets
- Foam inserts and mesh backing for comfort
- Reinforced bottom loading plate pockets
- Two-point emergency release system
- Kangaroo pouch
- Vest offered in S-XL sizes

Options

- ID Placards
- Level III or Level IV plates
- Special threat plates
- Available cummerbund soft armor inserts
- ACE accessories
- Kangaroo pouch insert

Available Colors



Black



Coyote



Ranger Green

Carrier Only - No Plates (45F34802V_)
Level IIIA - 3BFA Ballistics Only (45F34132V_)

Contact us for Ballistic Requirements and Ordering Instructions

Contract Availability



FEDMALL



GSA ADVANTAGE

“Right Away - Yours”

TACTICAL

Hydration Packs

SOURCE is the only hydration system in the market with a Glass-Like film that requires almost no maintenance to stay clean and bio-film free.



The Tactical 3L Hydration Pack is our most popular hydration system. It can be worn backpack style, inserted in a packpack, or directly attached via MOLLE on vests or backpacks using the QCA buckle system.



Part Number	Description
434000330102	Tactical 2L Hydration Pack - Black
434000330103	Tactical 3L Hydration Pack - Black

Additional Color Options:

Coyote, German Flecktarn Desert, Multicam, Olive, German Flecktarn Woodland

★ PROPPER™

Series 300 Boot

Designed to meet the toughest military specs, the Propper Series 300® boot is AR670-1 and Berry compliant. Made in USA.

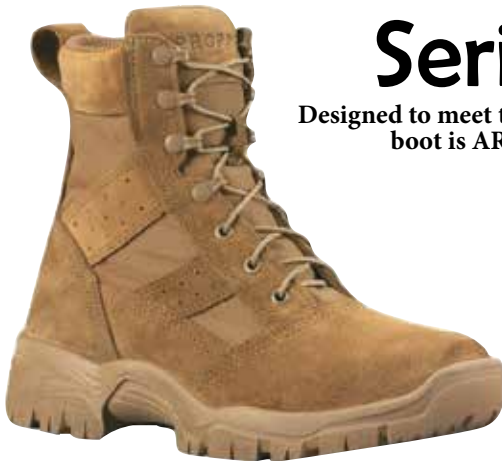

Available on



SP47W1-17-D-0028



MEN

WOMEN

Part Number	Description (sizes 3 - 16 half sizes starting at 3.5)
76F45263G2368M	Boots, Hot Weather, AR670-1 Compliant, Coyote, 8
76F45263G2369M	Boots, Hot Weather, AR670-1 Compliant, Coyote, 9
76F45263G23610M	Boots, Hot Weather, AR670-1 Compliant, Coyote, 10
76F45263G23611M	Boots, Hot Weather, AR670-1 Compliant, Coyote, 11
76F45263G23612M	Boots, Hot Weather, AR670-1 Compliant, Coyote, 12

Part Number	Description (sizes 3 - 16 half sizes starting at 3.5)
76F45263G2368W	Boots, Hot Weather, AR670-1 Compliant, Coyote, 8
76F45263G2369W	Boots, Hot Weather, AR670-1 Compliant, Coyote, 9
76F45263G23610W	Boots, Hot Weather, AR670-1 Compliant, Coyote, 10
76F45263G23611W	Boots, Hot Weather, AR670-1 Compliant, Coyote, 11
76F45263G23612W	Boots, Hot Weather, AR670-1 Compliant, Coyote, 12



TO ORDER

Call: 1-757-431-0698

email: RAYCO@RAYCOSUPPLY.COM

Visit our website: RAYCOSUPPLY.COM

TACTICAL

FORTREX® COMBAT SHIRT (NAVAIR)



- NAVAIR approved
- Navy and USMC “Safe to Fly”
- Made with proprietary DRIFIRE FORTREX® 4.5 oz. ultra-lightweight and durable FR fabric
- Inherent and permanent flame resistance, moisture management, and odor control
- Dries up to three times faster than cotton
- Excellent tensile and tear strengths
- Cool, breathable fabric minimizes heat build up
- Multi-environment colors hide dirt and minimize overheating
- Zippered neck closure
- Works as a system with the FORTREX™ 2-Piece Flight Suit (NAVAIR), interchangeable with jacket



SAGE



TAN

COMBAT SHIRT					COMBAT PANTS			
SIZE	ALTER	CHEST	HEIGHT	SLEEVE LENGTH	SIZE	ALTER	WAIST	INSEAM
X-SMALL	Short	< 33	63 - 67	30	X-SMALL	Short	< 27	26 1/2" - 29 1/2"
	Regular	< 33	67 - 71	31		Regular	< 27	29 1/2" - 32 1/2"
	Long	< 33	71 - 75	32		Long	< 27	32 1/2" -
SMALL	Short	33 - 37	63 - 67	31	SMALL	Short	31 - 35	26 1/2" - 29 1/2"
	Regular	33 - 37	67 - 71	32		Regular	31 - 35	29 1/2" - 32 1/2"
	Long	33 - 37	71 - 75	33		Long	31 - 35	32 1/2" - 35 1/2"
MEDIUM	Short	37 - 41	63 - 67	32	MEDIUM	Short	31 - 35	26 1/2" - 29 1/2"
	Regular	37 - 41	67 - 71	33		Regular	31 - 35	29 1/2" - 32 1/2"
	Long	37 - 41	71 - 75	34		Long	31 - 35	32 1/2" - 35 1/2"
LARGE	Short	41 - 45	63 - 67	33	LARGE	Short	35 - 39	26 1/2" - 29 1/2"
	Regular	41 - 45	67 - 71	34		Regular	35 - 39	29 1/2" - 32 1/2"
	Long	41 - 45	71 - 75	35		Long	35 - 39	32 1/2" - 35 1/2"
X-LARGE	Short	45 - 49	63 - 67	34	X-LARGE	Short	39 - 43	26 1/2" - 29 1/2"
	Regular	45 - 49	67 - 71	35		Regular	39 - 43	29 1/2" - 32 1/2"
	Long	45 - 49	71 - 75	36		Long	39 - 43	32 1/2" - 35 1/2"
XX-LARGE	Short	> 49	63 - 67	35	XX-LARGE	Short	> 43	26 1/2" - 29 1/2"
	Regular	> 49	67 - 71	36		Regular	> 43	29 1/2" - 32 1/2"
	Long	> 49	71 - 75	37		Long	> 43	32 1/2" - 35 1/2"

(Sleeve Length from Neck Seam to End of Cuff)

For waist sizes close to maximum expanded width, it is recommended to move to next size up for better comfort and fit.

*** Specify Size and Length ***



Sage



Tan

76DF27129CS450SG 76DF27129CS450TN

Available on



SP47W1-17-D-0028



Schedule 84 GS-07F-074BA

Contract Availability



FEDMALL

GSA ADVANTAGE

“Right Away - Yours”

TACTICAL

FR Control Base Layers



76C51FRSR

The FR Control Short & Long Sleeve t-shirt features lightweight breathable fabric, heat stress reduction and unsurpassed moisture wicking, drying rate, and odor control technology. Inherently FR and Made in the USA this fabric proactively regulates skin temperature (+/- 3 degrees) and reduces perspiration by as much as 34%.



FR Control™ / FR Control 2.0™ Tees (C51/C52)	
Size	Chest
SM	25" - 29"
MD	29" - 33"
LG	33" - 37"
XL	37" - 41"
2X	41" - 45"
3X	45" - 49"
4X	49" - 53"
5X	53" - 57"

- Arc Rating: 3.6 cal/cm²
- CAT 1
- Fabric/Material: 4 oz. FR CONTROL™
- Proactively regulates body temperature (+/- 3 degrees)
- Heat stress reduction
- Tagless shirt collar
- Inherently flame resistant, FR protection will not wash/wear out
- Lightweight, breathable fabric
- Odor control
- Reduces perspiration by as much as 34%
- Superior moisture wicking and dry rate
- Made in the USA



76C51FRSRLS



**NATIONAL
SAFETY APPAREL®**



TACTICAL

Vizable FR Hi-Vis

MENS LONG SLEEVE



76C54HYLSC3

WOMENS V-NECK



76C54HYLSC3W



Size	Men			Women		
	Chest	Sleeve	Length	Chest	Sleeve	Length
Small	34"-36"	31.5"	34"-36"	34"-36"	31.5"	34"-36"
Medium	37"-39"	32.5"	38"-40"	38"-40"	32.5"	38"-40"
Large	40"-43"	34.5"	42"-44"	42"-44"	34.5"	42"-44"
X-Large	44"-48"	35.5"	46"-48"	46"-48"	35.5"	46"-48"
2X-Large	49"-53"	36.5"	50"-52"	50"-52"	36.5"	50"-52"
3X-Large	54"-58"	37.5"	54"-56"	54"-56"	37.5"	54"-56"

- Arc Rating: 10 cal/cm²
- CAT 2
- Fabric/Material: 7.75 oz. Mod. Blend Knit
- Lightweight and breathable
- FR fabric will not melt, drip or ignite
- Tagless neckline with smooth covered neck and shoulder seams
- Rib knit cuffs keep sleeves in place
- Segmented 3M Scotchlite™ FR reflective trim
- Inherently flame resistant, FR protection will not wash/wear out
- Made in the USA



**NATIONAL
SAFETY APPAREL**

Vizable FR Hi-Vis Survey Vest

76VNT99375



- Arc Rating: 9.4 cal/cm²
- CAT 2
- Fabric/Material: 6.5 oz. FR Hi-Breathable modacrylic blend twill
- Moisture wicking and breathable
- Inherently flame resistant, FR protection will not wash/wear out
- Dielectric zip front closure
- Right chest cell phone pocket, left chest double pencil/tool pocket with 6 pencil/tool slots, back inside survey pocket, and two lower pockets
- Mic-clip band on left shoulder
- 3M Scotchlite™ silver FR solid reflective material



All NSA Items Available On

“Right Away - Yours”



FEDMALL



GSA ADVANTAGE

TACTICAL

MILITARY ULTRA-LIGHTWEIGHT Base Layers



Soft and ultra-lightweight, this fabric has superior wicking and fast-drying abilities that work to regulate body temperature. With built-in antimicrobial odor control and no-melt, no-drip flame resistance, it is sure to be your new favorite base layer.

- 4.5 oz. ultra-lightweight, soft FR fabric prevents chafing and maximizes comfort
- Perfect base layer for other DRIFIRE garments
- Inherent and permanent flame resistance, moisture management, and odor control
- Dries up to three times faster than cotton
- Made in the USA



Available Colors



Black



Coyote Brown



Desert Sand

76DF4505L

* Specify Size when ordering *



TO ORDER

Call: 1-757-431-0698

email: RAYCO@RAYCOSUPPLY.COM

Visit our website: RAYCOSUPPLY.COM

TACTICAL

MILITARY DRIFIRE PRIME™ Base Layers

What's underneath counts — for safety and performance.
That's why DRIFIRE PRIME™ should always go on first.

With its signature flat-locked stitching, the premium four-way stretch fabric of DRIFIRE PRIME provides maximum flexibility, style and comfort.

- DRIFIRE PRIME™
- Lightweight 6.5 oz. FR fabric with super soft feel
- Supple, four-way stretch increases mobility and range of motion
- Smart-fit and athletic-cut designed to feel like “second skin”
- Offset, flatlock seams for no-rub comfort
- Inherent and permanent flame resistance, moisture management, and odor control
- Dries up to three times faster than cotton
- Made in the USA



KNIT SHIRTS - CHEST SIZE (INCHES)						
FABRIC TYPE	SMALL	MEDIUM	LARGE	X-LARGE	XX-LARGE	XXX-LARGE
Ultra-Lightweight	36	40	44	48	52	56
Lightweight	36	40	44	48	52	56
Midweight	38	42	46	50	54	58
Heavyweight	38.5	42.5	46.5	50.5	54.5	58.5
Fleece	44	48	53	56	60	64

Desert Sand
 Long Sleeve
 76DF2MIL762PLSDS
 Short Sleeve
 76DF2MIL762PTSDS

Coyote Brown
 Long Sleeve
 76DF2MIL762PLSCB
 Short Sleeve
 76DF2MIL762PTSCB

* Specify Size when ordering *



All DRIFIRE Items Available On



“Right Away - Yours”

TACTICAL

HEAVYWEIGHT Base Layers

8.75 oz. heavyweight, soft FR fabric prevents chafing and maximizes comfort

Long Sleeve Tee & Long John Pant



76DF2245LS_



76DF2245LS_



76DF2245LP_

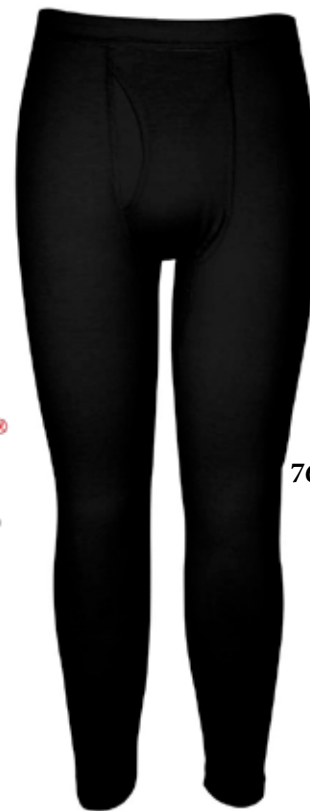

76DF2245LP_



Available Colors



Coyote Brown



Black



Desert Sand

* Specify Size & Color when ordering *



TO ORDER

Call: 1-757-431-0698

email: RAYCO@RAYCOSUPPLY.COM

Visit our website: RAYCOSUPPLY.COM

BDU Trouser - Button Fly



Features:

- Sewn to military specification MIL-T-44047E
- Fused pocket flaps for clean, professional look
- Six-pocket design (four with button flaps)
- Drain holes in belloved pockets
- Durable drawstring leg closures
- Adjustable waist tabs for secure fit
- Felled seams for durability
- Reinforced seat and knee
- 60% cotton / 40% polyester twill



Waist Sizes:
Small : 27 - 31, Medium : 31 - 35
Large : 35 - 39, X Large : 39 - 43
XX Large : 43 - 47

Inseam Sizes:
Regular : 29 1/2 - 32 1/2
Long : 32 1/2 - 35 1/2

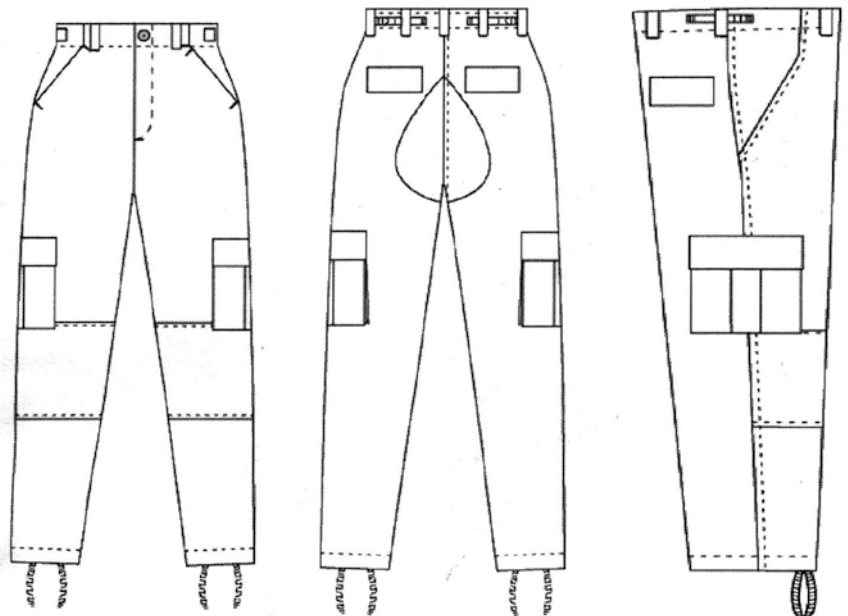
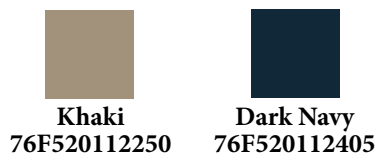

***** Specify Waist & Inseam when ordering *****

“Right Away - Yours”

All Items Available On



FEDMALL

GSA ADVANTAGE

JANITORIAL

Janitorial & Sanitation



Part Number	Description
6401011BLA	Structural Foam Tilt Trucks, 3/4 yd3, 600 lb
41205812	WypAll L30 Wipers, White, 90 per pack, 12/Case
6402005CC	Dust Pans, 8 1/4 in x 12 1/4 in, Plastic, Charcoal
6402531BLA	Dust Pans, w/handle, 11 1/4 in x 12 4/5 in, Plastic, Black
6402963GRAY	10Qt Round Brute Bucket Gray
6406375GRAY	Rubbermaid Angle Brooms, Polypropylene Block, Flagged Polypropylene
78010383	Lava Pumice Hand Cleaners, Unscented, Bar 48/CA
8712016C	Cut-End Wet Mop Heads, Value Standard Head, #16, Cotton; Polyester Headband

ALL TYPES OF
SPILL KITS AVAILABLE!!

Part Number	Description
15835306	Formula 409 Cleaner Degreaser/Disinfectant, 32 oz Trigger Spray Bottle 12/Case
640450088BLA	Utility Carts, 500 lb, 39 1/4 X 17 7/8 X 33 1/4h, Black
640452088BLA	Utility Carts, 500 lb, 45 1/4 X 25 7/8 X 33 1/4h, Black
6762710001213012	Industrial Cleaner/Degreasers, 24 oz Spray Bottle
0881001	Red Cherry Urinal Screen
088NUS	Non-Para Urinal Screen with Cleaner Block
23402203	Boraxo Powdered Hand Soaps, Unscented, Box
574D3865	Puncture Resistant Industrial Drum Liners, 60 gal, 2.5 mil, 38 X 65, Clear



Part Number	Description
73802775	Professional Lysol Brand Disinfectant Foam Cleaner, 24 oz Aerosol Can, 12/CA
39590122	Bag-in-Box Dispensers, 5 gal Bag-in-Box
73874278	Professional Lysol Brand Disinfectant Toilet Bowl Cleaner, 32 oz Bottle
0191038801	Misty AMR R930-12 32 Oz. Secure 9 Percent HCl Bowl Cleaner
721CS2	Cellulose Sponges, Medium
721196	Medium-Duty Scour Pads
15835418	Pine-Sol Liquid Cleaner, Disinfectant, Deodorizer, Pine Scent, 144 oz Bottle 3/CA



JANITORIAL

Part Number	Description
25342272	SCRUBS Hand Cleaner Towels, Wet Wipe Bucket, 72 per pail, 6/CA
795HB5530	Trash Can Liners, 55 gal, 3 mil, 36 X 56, Black 30/Box
41234790	WypAll X60 Wipers, Pop-Up Box, White, 126 per Box
315095504	Natural Orange Pumice Hand Cleaners, Citrus, Bottle w/Pump, 1 gal 4/CA
41241043	WypAll X80 Towels, Jumbo Roll, Blue, 475 per Roll
407101P	All Purpose Hand Cleaners, Plastic Container 6/CA
60802611	Dawn Dishwashing Liquid, Original Scent, 5 Gallon Pail
41275190	Scott Shop Towels, Pop-Up Box, Blue, 8/CA



Part Number	Description
6402655GRAY	Brute Round Containers, 55 gal, Plastic, Gray
41241041	WypAll X80 Towels, Brag Box, Blue, 160 per Box
41275130	Scott Shop Towels, Blue, 55 per roll 30RL/CA
41291371	WypAll Waterless Hand Wipes, Citrus, Bucket, 42 oz, 6/CA
41275260	Scott Rags In-A-Box, Pop-Up Box, White, 200 Sheets, 8/CA
315225704	Micrell NXT Antibacterial Lotion Soap, 2000mL Refill, 4/CA
407105	All Purpose Hand Cleaners, Squeeze Tube, 14 oz, 12/CA
103FLOORSWEEP	Floor Sweep 50 lb

Part Number	Description
0886180	Bathroom Tissues, 4 1/2 in x 3 in, 2,250 ft, 96/CA
41241044	WypAll X80 Towels, Brag Box, White, 160 per Box
41234965	WypAll X60 Wipers, Jumbo Roll, Blue, 1,100 per Roll
795HB5530R	Trash Can Liners with Recycled Plastic, 55 gal, 3 mil, 36 X 56, Black
60845112	Dawn Dishwashing Liquid, Original Scent, 38 oz Bottle, 8/CA
0886272	Household Perforated Paper Towel Rolls, White, 30/CA
41234015	WypAll X60 Wipers, Brag Box, White







“Right Away - Yours”

Contract Availability





Rayco Supply, Inc is Proud to be an Ability One / National Industries for the Blind Distributor

Part Number	Description
4331430172 	Citris Ginger Foam Hand & Showerwash, Includes: GOJO ADX-12 Soap Dispensers with Specified Branch Graphic, * 3 Per Case
4331430171 	Plum Foam Handwash, Includes: GOJO ADX-12 Soap Dispensers with Specified Branch Graphic, * 3 Per Case
4331430169	Hand Sanitizer, Purell, Green Certified, Includes: Purell ADX-12 Dispenser - White * 3 Per Case
4331430140 	Hand Sanitizer Pump, Purell, 2 Liter * 4 Per Case
4331430164 	Military Field Hygiene Stand, Purell



4331410071

4331430172



4331430171

*** Also Available ***

Office Essentials

Cleaning & Sanitary Supplies

Hardware & Paints

4331430169



4331430164



CAPABILITIES

Providing Quality Products for Over 27 Years - Woman-Owned Small Business

Damage Control

Mil-Spec Fire Hoses
AFFF
Wrenches
Hose Reels
Deck Drains
Sounding Tape

Engraving

Engravers
Engraving Plastics
Name Tags
Backings
Ribbon Bars
Plaques
Engraving Brass

Tools

Hand Tools
Power Tools
Pneumatic Tools
Tool Cabinets & Chests
Machinery

Plumbing

Drain Rooters
Flushometers
Water Rams
Urinals, Toilets,
Shower Heads
Specialized Tools
Repair Parts

Clothing

Proximity
Fire Fighting
Anti-Flash & Arc
Coveralls
Flight Deck
Flight Suit
Hoods & Helmets
Work Uniforms

Welding

Welders
Torches
Plasma Cutters
Tips
Electrodes
Rods
Wires
Consumables
Repair Parts

Valves

Gate
Globe
Angle
Butterfly
Check
Various Sizes
Various Connections
Hand Wheels

Shipboard

Gangways
Toggle Pins
Ladders
Water Tight Doors
Ladder Treads
Deck Grating
Repair Parts
Lighting

Pipes, Fittings, Flanges & Metals

Copper Nickel
SIL-Brazed
Monel
Steel
Aluminum
Brass
Various Metal & Alloys
Sheet Metal & Plate
Navy or Standard
Various Sizes & Connections
Flat Bar & Angle
Round Stock

Fasteners

Various Alloys
& Materials
Mil-Spec Standards
Bolts, Screws,
Nuts, Washers
Various Styles

* Rayco Supply is able to provide MORE than just the items in this catalog.
Please feel free to contact us with any of your supply needs! *

“Right Away - Yours”



MISSION STATEMENT

TO CONDUCT BUSINESS WITH INTEGRITY,
FAIRNESS, AND HONESTY TO BOTH EXTERNAL AND
INTERNAL CUSTOMERS. TO PROVIDE OUR
CUSTOMERS WITH THE BEST VALUE PRODUCT. TO
SATISFY AND EXCEED EXPECTATIONS ON COST,
QUALITY, AND TIMELINESS.

HENCE OUR MOTTO “RIGHT AWAY - YOURS”

OUR QUEST IS TO BE COMPETITIVE, PROFITABLE,



AND ADMIRER



...TO BE THE BEST...

Rayco Supply Contact Information

Phone: 757-431-0698 Fax: 757-431-2634

Email: Rayco@raycosupply.com

www.raycosupply.com

Our Company Proudly Supports Green Practices